

## User Manual



# MINIMON MON800

Ultra-Compact Stereo Monitor Matrix Mixer with Talkback Mic

## Table of Contents

<b>Thank you .....</b>	<b>2</b>
<b>Important Safety Instructions.....</b>	<b>3</b>
<b>Legal Disclaimer.....</b>	<b>3</b>
<b>Limited Warranty .....</b>	<b>4</b>
<b>1. Introduction.....</b>	<b>6</b>
1.1 Before you get started .....	6
<b>2. MON800 Quick-Start Set-Up.....</b>	<b>7</b>
<b>3. Control Elements and Connections .....</b>	<b>8</b>
3.1 Front panel .....	8
3.2 Rear panel.....	9
<b>4. Application Examples.....</b>	<b>9</b>
4.1 The MINIMON in a recording environment.....	9
4.2 Using the MINIMON for signal distribution in simple P.A. applications .....	11
<b>5. Audio Connections.....</b>	<b>12</b>
5.1 Connection with ¼" or cinch cables .....	12
5.2 Footswitch connection .....	12
5.3 Headphones connection.....	12
<b>6. Specifications .....</b>	<b>13</b>
<b>7. Other Mini Products .....</b>	<b>14</b>

### Thank you

Thank you for showing your confidence in BEHRINGER products by purchasing the MINIMON MON800. With the MINIMON MON800 you have purchased a flexible monitoring unit, which allows you to control a variety of signals during music production. You can use the MON800 as an add-on unit to a mixing console with only limited monitoring capabilities, or you can use it without a console at all. With the flick of a switch you can listen to your productions over different loudspeaker systems and thus be able to identify mixing problems at an early stage. Recording musicians can be provided with appropriate monitor signals and thanks to the talk-back microphone it's you who has the entire recording process under control

## EN Important Safety Instructions





 Terminals marked with this symbol carry electrical current of sufficient magnitude to constitute risk of electric shock. Use only high-quality professional speaker cables with ¼" TS or twist-locking plugs pre-installed. All other installation or modification should be performed only by qualified personnel.

 This symbol, wherever it appears, alerts you to the presence of uninsulated dangerous voltage inside the enclosure - voltage that may be sufficient to constitute a risk of shock.

 This symbol, wherever it appears, alerts you to important operating and maintenance instructions in the accompanying literature. Please read the manual.

 **Caution**  
To reduce the risk of electric shock, do not remove the top cover (or the rear section). No user serviceable parts inside. Refer servicing to qualified personnel.

 **Caution**  
To reduce the risk of fire or electric shock, do not expose this appliance to rain and moisture. The apparatus shall not be exposed to dripping or splashing liquids and no objects filled with liquids, such as vases, shall be placed on the apparatus.

 **Caution**  
These service instructions are for use by qualified service personnel only. To reduce the risk of electric shock do not perform any servicing other than that contained in the operation instructions. Repairs have to be performed by qualified service personnel.

1. Read these instructions.
2. Keep these instructions.
3. Heed all warnings.
4. Follow all instructions.
5. Do not use this apparatus near water.
6. Clean only with dry cloth.
7. Do not block any ventilation openings. Install in accordance with the manufacturer's instructions.
8. Do not install near any heat sources such as radiators, heat registers, stoves, or other apparatus (including amplifiers) that produce heat.
9. Do not defeat the safety purpose of the polarized or grounding-type plug. A polarized plug has two blades with one wider than the other. A grounding-type plug has two blades and a third grounding prong. The wide blade or the third prong are provided for your safety. If the provided plug does not fit into your outlet, consult an electrician for replacement of the obsolete outlet.
10. Protect the power cord from being walked on or pinched particularly at plugs, convenience receptacles, and the point where they exit from the apparatus.
11. Use only attachments/accessories specified by the manufacturer.



12. Use only with the cart, stand, tripod, bracket, or table specified by the manufacturer, or sold with the apparatus. When a cart is used, use caution when moving the cart/apparatus combination to avoid injury from tip-over.

13. Unplug this apparatus during lightning storms or when unused for long periods of time.

14. Refer all servicing to qualified service personnel. Servicing is required when the apparatus has been damaged in any way, such as power supply cord or plug is damaged, liquid has been spilled or objects have fallen into the apparatus, the apparatus has been exposed to rain or moisture, does not operate normally, or has been dropped.

15. The apparatus shall be connected to a MAINS socket outlet with a protective earthing connection.
16. Where the MAINS plug or an appliance coupler is used as the disconnect device, the disconnect device shall remain readily operable.



## LEGAL DISCLAIMER

TECHNICAL SPECIFICATIONS AND APPEARANCES ARE SUBJECT TO CHANGE WITHOUT NOTICE AND ACCURACY IS NOT GUARANTEED. BEHRINGER IS PART OF THE MUSIC GROUP (MUSIC-GROUP.COM). ALL TRADEMARKS ARE THE PROPERTY OF THEIR RESPECTIVE OWNERS. MUSIC GROUP ACCEPTS NO LIABILITY FOR ANY LOSS WHICH MAY BE SUFFERED BY ANY PERSON WHO RELIES EITHER WHOLLY OR IN PART UPON ANY DESCRIPTION, PHOTOGRAPH OR STATEMENT CONTAINED HEREIN. COLORS AND SPECIFICATIONS MAY VARY FROM ACTUAL PRODUCT. MUSIC GROUP PRODUCTS ARE SOLD THROUGH AUTHORIZED FULLFILLERS AND RESELLERS ONLY. FULLFILLERS AND RESELLERS ARE NOT AGENTS OF MUSIC GROUP AND HAVE ABSOLUTELY NO AUTHORITY TO BIND MUSIC GROUP BY ANY EXPRESS OR IMPLIED UNDERTAKING OR REPRESENTATION. THIS MANUAL IS COPYRIGHTED. NO PART OF THIS MANUAL MAY BE REPRODUCED OR TRANSMITTED IN ANY FORM OR BY ANY MEANS, ELECTRONIC OR MECHANICAL, INCLUDING PHOTOCOPYING AND RECORDING OF ANY KIND, FOR ANY PURPOSE, WITHOUT THE EXPRESS WRITTEN PERMISSION OF MUSIC GROUP IP LTD.

ALL RIGHTS RESERVED.  
© 2012 MUSIC Group IP Ltd.  
Trident Chambers, Wickhams Cay,  
P.O. Box 146, Road Town, Tortola,  
British Virgin Islands

## LIMITED WARRANTY

### § 1 Warranty

① This limited warranty is valid only if you purchased the product from a MUSIC Group Authorized Reseller in the country of purchase. A list of authorized resellers can be found on BEHRINGER's website behringer.com under "Where to Buy", or you can contact the MUSIC Group office closest to you.

② MUSIC Group\* warrants the mechanical and electronic components of this product to be free of defects in material and workmanship if used under normal operating conditions for a period of one (1) year from the original date of purchase (see the Limited Warranty terms in § 4 below), unless a longer minimum warranty period is mandated by applicable local laws. If the product shows any defects within the specified warranty period and that defect is not excluded under § 4, MUSIC Group shall, at its discretion, either replace or repair the product using suitable new or reconditioned product or parts. In case MUSIC Group decides to replace the entire product, this limited warranty shall apply to the replacement product for the remaining initial warranty period, i.e., one (1) year (or otherwise applicable minimum warranty period) from the date of purchase of the original product.

③ Upon validation of the warranty claim, the repaired or replacement product will be returned to the user freight prepaid by MUSIC Group.

④ Warranty claims other than those indicated above are expressly excluded. PLEASE RETAIN YOUR SALES RECEIPT. IT IS YOUR PROOF OF PURCHASE COVERING YOUR LIMITED WARRANTY. THIS LIMITED WARRANTY IS VOID WITHOUT SUCH PROOF OF PURCHASE.

### § 2 Online registration

Please do remember to register your new BEHRINGER equipment right after your purchase at behringer.com under "Support" and kindly read the terms and conditions of our limited warranty

carefully. Registering your purchase and equipment with us helps us process your repair claims quicker and more efficiently. Thank you for your cooperation!

### § 3 Return materials authorization

① To obtain warranty service, please contact the retailer from whom the equipment was purchased. Should your MUSIC Group Authorized Reseller not be located in your vicinity, you may contact the MUSIC Group Authorized Fulfiller for your country listed under "Support" at behringer.com. If your country is not listed, please check if your problem can be dealt with by our "Online Support" which may also be found under "Support" at behringer.com. Alternatively, please submit an online warranty claim at behringer.com BEFORE returning the product. All inquiries must be accompanied by a description of the problem and the serial number of the product. After verifying the product's warranty eligibility with the original sales receipt, MUSIC Group will then issue a Return Materials Authorization ("RMA") number.

② Subsequently, the product must be returned in its original shipping carton, together with the return authorization number to the address indicated by MUSIC Group.

③ Shipments without freight prepaid will not be accepted.

### § 4 Warranty Exclusions

① This limited warranty does not cover consumable parts including, but not limited to, fuses and batteries. Where applicable, MUSIC Group warrants the valves or meters contained in the product to be free from defects in material and workmanship for a period of ninety (90) days from date of purchase.

② This limited warranty does not cover the product if it has been electronically or mechanically modified in any way. If the product needs to be modified or adapted in order to comply with applicable technical or safety standards on a national or local level, in any country

which is not the country for which the product was originally developed and manufactured, this modification/adaptation shall not be considered a defect in materials or workmanship. This limited warranty does not cover any such modification/adaptation, regardless of whether it was carried out properly or not. Under the terms of this limited warranty, MUSIC Group shall not be held responsible for any cost resulting from such a modification/adaptation.

③ This limited warranty covers only the product hardware. It does not cover technical assistance for hardware or software usage and it does not cover any software products whether or not contained in the product. Any such software is provided "AS IS" unless expressly provided for in any enclosed software limited warranty.

④ This limited warranty is invalid if the factory-applied serial number has been altered or removed from the product.

⑤ Free inspections and maintenance/repair work are expressly excluded from this limited warranty, in particular, if caused by improper handling of the product by the user. This also applies to defects caused by normal wear and tear, in particular, of faders, crossfaders, potentiometers, keys/buttons, guitar strings, illuminants and similar parts.

⑥ Damage/defects caused by the following conditions are not covered by this limited warranty:

- improper handling, neglect or failure to operate the unit in compliance with the instructions given in BEHRINGER user or service manuals;
- connection or operation of the unit in any way that does not comply with the technical or safety regulations applicable in the country where the product is used;
- damage/defects caused by acts of God/Nature (accident, fire, flood, etc) or any other condition that is beyond the control of MUSIC Group.

⑦ Any repair or opening of the unit carried out by unauthorized personnel (user included) will void the limited warranty.

⑧ If an inspection of the product by MUSIC Group shows that the defect in question is not covered by the limited warranty, the inspection costs are payable by the customer.

⑨ Products which do not meet the terms of this limited warranty will be repaired exclusively at the buyer's expense. MUSIC Group or its authorized service center will inform the buyer of any such circumstance. If the buyer fails to submit a written repair order within 6 weeks after notification, MUSIC Group will return the unit C.O.D. with a separate invoice for freight and packing. Such costs will also be invoiced separately when the buyer has sent in a written repair order.

⑩ MUSIC Group Authorized Resellers do not sell new products directly in online auctions. Purchases made through an online auction are on a "buyer beware" basis. Online auction confirmations or sales receipts are not accepted for warranty verification and MUSIC Group will not repair or replace any product purchased through an online auction.

### § 5 Warranty transferability

This limited warranty is extended exclusively to the original buyer (customer of authorized reseller) and is not transferable to anyone who may subsequently purchase this product. No other person (reseller, etc.) shall be entitled to give any warranty promise on behalf of MUSIC Group.

### § 6 Claim for damage

Subject only to the operation of mandatory applicable local laws, MUSIC Group shall have no liability to the buyer under this warranty for any consequential or indirect loss or damage of any kind. In no event shall the liability of MUSIC Group under this limited warranty exceed the invoiced value of the product.

### § 7 Limitation of liability

This limited warranty is the complete and exclusive warranty between you and MUSIC Group. It supersedes all other written or oral communications related to this product. MUSIC Group provides no other warranties for this product.

### § 8 Other warranty rights and national law

- ① This limited warranty does not exclude or limit the buyer's statutory rights as a consumer in any way.
- ② The limited warranty regulations mentioned herein are applicable unless they constitute an infringement of applicable mandatory local laws.
- ③ This warranty does not detract from the seller's obligations in regard to any lack of conformity of the product and any hidden defect.

### § 9 Amendment

Warranty service conditions are subject to change without notice. For the latest warranty terms and conditions and additional information regarding MUSIC Group's limited warranty, please see complete details online at [behringer.com](http://behringer.com).

\* MUSIC Group Macao Commercial Offshore Limited of Rue de Pequim No. 202-A, Macau Finance Centre 9/J, Macau, including all MUSIC Group companies

## 1. Introduction

The MON800 features a clearly structured input section with four selectable and mixable stereo inputs, as well as a high-precision, 6-digit LED output level meter for accurate level control. It also includes a powerful headphones output with its own volume control, plus three selectable stereo loudspeaker outputs with separate volume controls for optimum adjustment.

The Mute and Dim functions as well as a mono switch for checking signals for mono compatibility (phase) give the MON800 even greater flexibility. The integrated talk-back section with its built-in microphone provides you with a full set of routing options. High-quality potentiometers and backlit switches ensure long-term reliability. What is more, our extremely low-noise operational amplifiers are synonymous for outstanding audio quality.

With the MON800 you have your music productions totally under control!

### 1.1 Before you get started

#### 1.1.1 Shipment

Your MON800 was carefully packed at the assembly plant to assure secure transport. Should the condition of the cardboard box suggest that damage may have taken place, please inspect the unit immediately and look for physical indications of damage.

- ◆ **Damaged equipment should NEVER be sent directly to us. Please inform the dealer from whom you acquired the unit immediately as well as the transportation company from which you took delivery. Otherwise, all claims for replacement/repair may be rendered invalid.**
- ◆ **Please always use the original packaging to avoid damage due to storage or shipping.**
- ◆ **Never let unsupervised children play with the MON800 or with its packaging.**
- ◆ **Please dispose of all packaging materials in an environmentally friendly fashion.**

#### 1.1.2 Initial operation

Be sure that there is enough space around the unit for cooling. To avoid overheating, do not place the MON800 on top of power amps or near radiators, etc.

- ◆ **To power the MON800, use only the power supply unit that is delivered with your equipment.**
- ◆ **Please ensure that the unit is installed and operated only by people qualified to do so. During installation and operation the user must have sufficient electrical contact to earth. Electrostatic discharge may affect the operation of the unit.**

#### 1.1.3 Online registration

Please register your new BEHRINGER equipment right after your purchase by visiting <http://behringer.com> and read the terms and conditions of our warranty carefully.

Should your BEHRINGER product malfunction, it is our intention to have it repaired as quickly as possible. To arrange for warranty service, please contact the BEHRINGER retailer from whom the equipment was purchased. Should your BEHRINGER dealer not be located in your vicinity, you may directly contact one of our subsidiaries. Corresponding contact information is included in the original equipment packaging (Global Contact Information/ European Contact Information). Should your country not be listed, please contact the distributor nearest you. A list of distributors can be found in the support area of our website (<http://behringer.com>).

Registering your purchase and equipment with us helps us process your repair claims more quickly and efficiently.

Thank you for your cooperation!

## 2. MON800 Quick-Start Set-Up

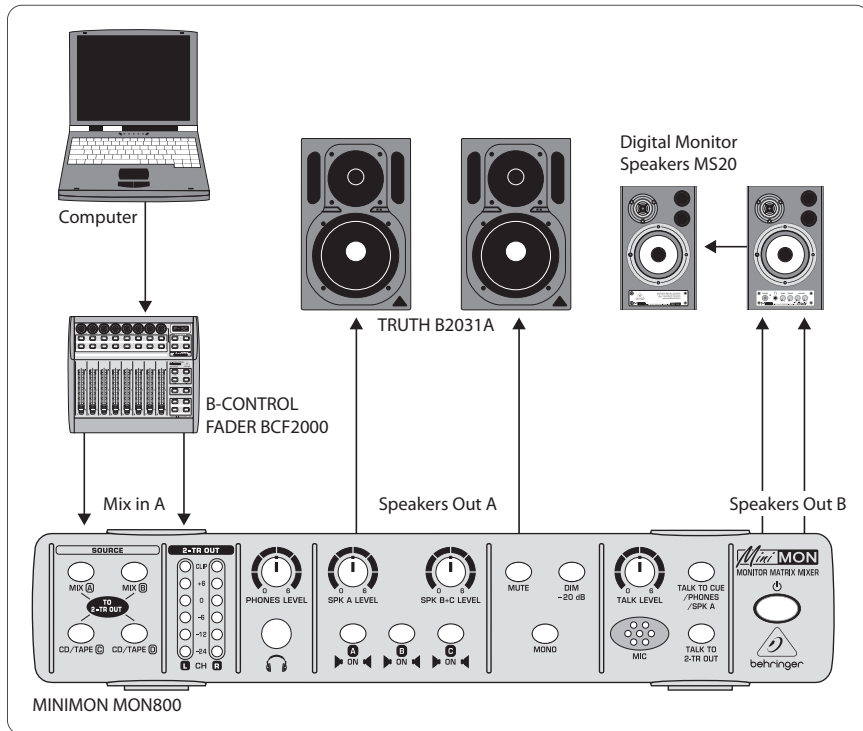

Fig. 2.1: MON800 quick-start set-up

Please follow the instructions below to set up the MON800 as a monitor unit with different speakers in your studio.

- Connect your computer or any other line-level source to the MIX IN A connectors on the MON800.
- Connect your main monitor speakers to the SPEAKERS OUT A connectors, and another pair of speakers to the B outputs.
- Press the MIX A switch in the SOURCE section.
- Use the 2-TR OUT LED display to check the signal level. If the CLIP LED lights up, please reduce the input signal level until it settles between the -6 dB and +6 dB markings.
- The switches A and B allow you to switch the pairs of speakers on and off. Activate the A speakers and adjust the desired volume with SPK A LEVEL.
- Switch off the A speakers and activate the B speakers. Use SPK B + C LEVEL to adjust a volume level that is roughly the same as the A speakers volume.
- Switch between the two pairs of speakers to check the volume levels. Align the volume if necessary.
- By switching between the two pairs of speakers you can evaluate your mixes by way of a direct comparison using two different monitor systems.

## EN 3. Control Elements and Connections

### 3.1 Front panel

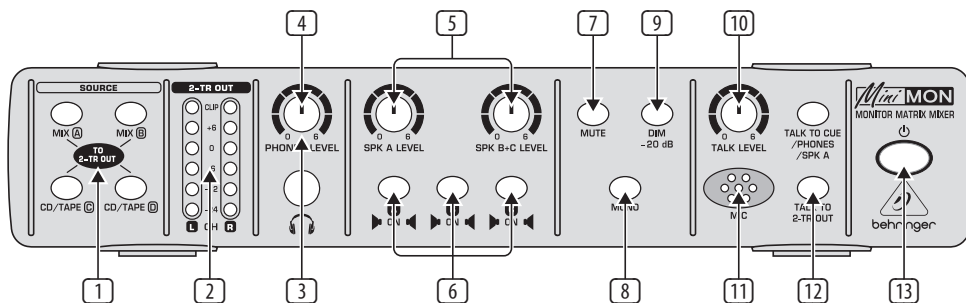

Fig. 3.1: Front panel control elements of the MON800

- 1 Use the four switches in the **SOURCE** section to select up to four input sources (MIX A and B, CD/TAPE C and D) for monitoring and recording. If desired, several sources can be activated at the same time. Subsequently, the signals are mixed. Each active source is indicated by its switch lighting up.
- 2 The two LED displays are for monitoring the output level of the 2-TRACK OUT outputs. They comprise 6 LEDs each. When the **CLIP** LED lights up, this indicates that distortion may occur. In this case, please reduce the levels of the signal sources connected to the input of the MON800.
- 3 A pair of headphones with a ¼" TRS connector (e.g. BEHRINGER HP55000) can be connected to the **PHONES** jack. This output is wired in parallel with the rear-panel output jack (15), so that up to two headphones can be used at the same time.
- 4 With the **PHONES LEVEL** control you can adjust the volume for the two headphones jacks on the front or rear panel respectively.
  - ♦ The volume on the headphones from the front and rear panel jacks cannot be adjusted separately.
- 5 **SPK A LEVEL** governs the volume level of the **SPEAKERS OUT A** outputs (18). **SPK B + C LEVEL** allows you to set the volume for outputs B and C (17) simultaneously.
- 6 Use the switches **A/B/C ON** to switch the speakers A, B and C on and off. While mixing it is advisable to listen to your production over at least two different pairs of speakers, so as to get an objective impression of your mix. If you wish to switch between different monitoring systems, press the corresponding switches of the active and of the inactive speaker pair one after the other. Active speakers are always indicated by their switches lighting up.
- 7 With the **MUTE** switch you can disable all loudspeaker and headphones outputs.
- 8 The **MONO** switch switches all monitor paths to mono. This is useful, in particular, when you want to check your mix for mono compatibility. Extreme panorama settings and excessive use of effects, such as chorus, phaser and flanger in the stereo mix can lead to signal cancellations during playback in mono. Such phase problems can easily be detected with the **MONO** switch.
- 9 The **DIM** switch lowers the level of the monitor paths by -20 dB. This allows you, for example, to talk to somebody while mixing without losing track of the recording.
  - ♦ Switches 7 to 9 light up when the corresponding functions are active. The functions performed by these switches do not affect the signals of the two 2-TRACK OUT outputs.
- 10 Use the **TALK LEVEL** control to adjust the sensitivity of the talk-back microphone.
- 11 The talk-back microphone is installed behind the **MIC** openings. Speak into the microphone to make announcements which are then routed to the recording devices connected to the 2-TRACK OUT outputs. This allows you to record the numbers or names of different recording takes, for example, and thus maintain a clear overview of your work. Additionally, the microphone can be used to communicate with the musicians who can hear your voice on their headphones.



12 The **TALK TO CUE/PHONES/SPK A** and **TALK TO 2-TR OUT** buttons determine where the talk-back microphone signal is routed to. With the **TALK TO CUE/PHONES/SPK A** button the signal is routed to the monitor paths CUE OUT, PHONES, PH and SPEAKERS OUT A. In this case, the DIM function 9 is activated automatically to avoid feedback. The TALK TO 2-TR OUT button allows you to route the signal via the two 2-TRACK OUT outputs to the recording devices connected.

◆ Hold the button down as long as you wish to speak.

### 3.2 Rear panel

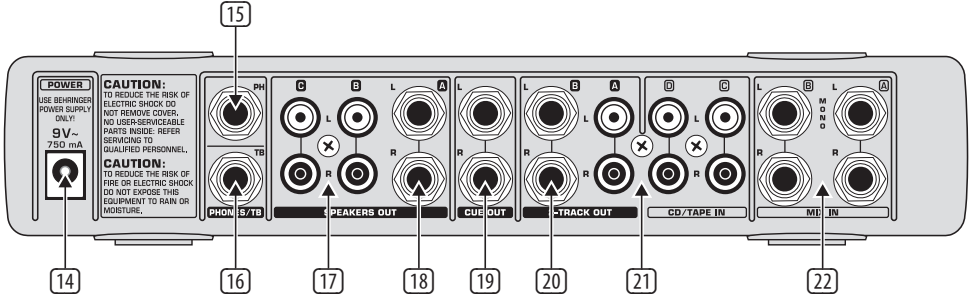

Fig. 3.2: Rear panel connectors of the MON800

14 The MON800 is connected to the mains using a 2-pole **POWER** connector jack. A matching mains adaptor is included with the unit.

◆ To avoid damage to your COM800 always use the mains adaptor supplied with the unit.

15 A second pair of headphones can be connected to the **PH** jack. This connector is wired in parallel with the front-panel jack 3.

16 The **TB** jack is used to connect a single footswitch. This footswitch allows hands-free talking and the use of the talk-back button 12 (TALK TO CUE/PHONES/SPK A) at the same time.

◆ Hold the button down as long as you wish to speak.

17 Two pairs of loudspeakers can be connected to the **SPEAKERS OUT** B and C jacks. Since the levels of both pairs (B and C) can only be adjusted together on the MON800, it's a good idea to connect one speaker pair to output B and an additional sub-woofer to output C (see chapter 4.1).

18 Connect your main monitor speakers to the **SPEAKERS OUT A** jack.

◆ The loudspeaker outputs are designed for the connection of active systems or an external amplifier with passive speakers.

13 The **⏻** switch turns your MINIMON MON800 on and off.

◆ Attention: The **⏻** switch does not fully disconnect the unit from the mains. To disconnect the unit from the mains, pull out the main cord plug or appliance coupler. When installing the product, ensure the plug or appliance coupler is readily operable. Unplug the power cord completely when the unit is not used for prolonged periods of time.

19 **CUE OUT** is an additional output, which you can use to route the MINIMON signals to other devices, such as an additional headphones amp (e.g. BEHRINGER MINIAMP AMP800) (see chapter 4.1).

◆ The **CUE OUT** level cannot be changed on the MON800.

20 The two **2-TRACK OUT** jacks are wired in parallel and carry the same signals. Use the 1/4" or cinch outputs, depending on the recording device used.

21 Use the **CD/TAPE IN** jacks C and D to connect playback devices, such as a computer, CD/MD or cassette player.

22 The **MIX IN** jacks A and B are for connecting the main signal sources (e.g. mixing console, audio card, etc.) using 1/4" plugs. Mono signals must be connected to the L jacks.

The **SERIAL NUMBER** of your MON800 can be found on the bottom side of the unit.

## 4. Application Examples

The MINIMON gives you a great number of monitoring options, which you would otherwise find only in costly mixing consoles. Therefore, an ideal field of application is to use the MON800 to control and distribute signals in a recording environment. However, with its flexibility the MON800 is also the ideal tool for P.A. applications.

### 4.1 The MINIMON in a recording environment

A typical example of how to use the MON800 is the computer-based production of music with additional instrument or voice recordings. The following illustration shows an example of how to wire the unit in such an environment.

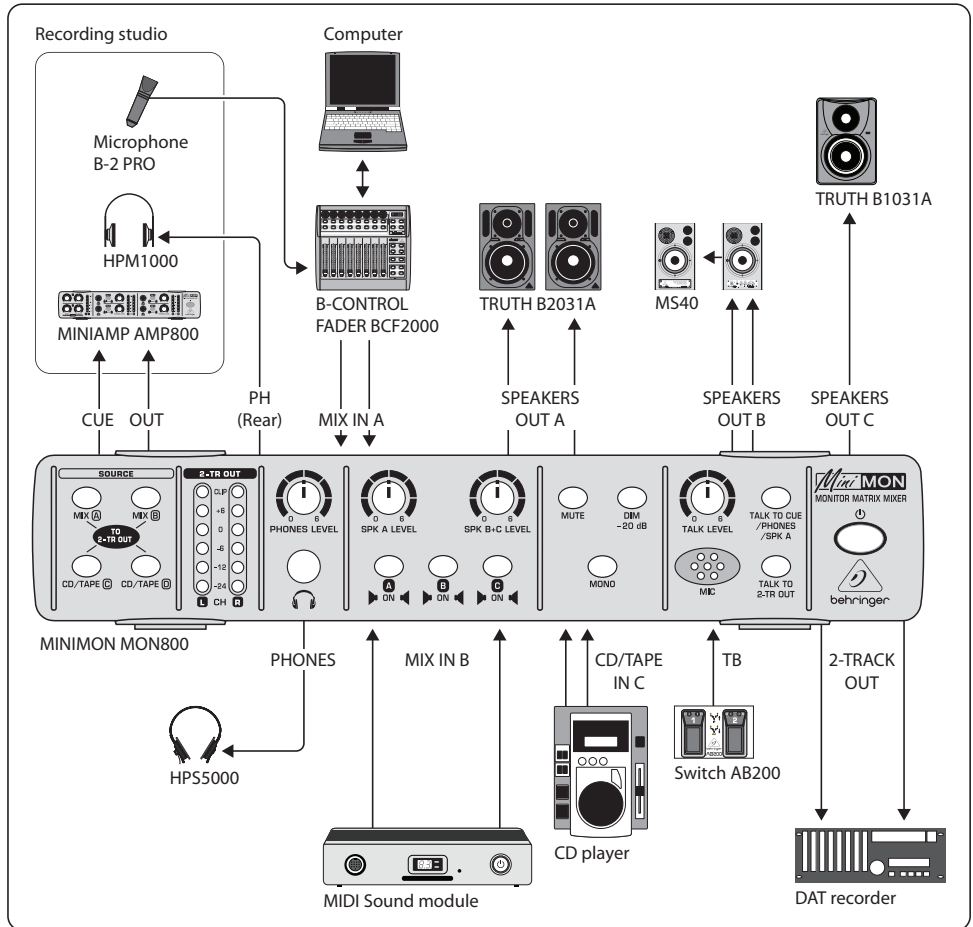

Fig. 4.1: The MON800 in a typical computer-based recording environment

As a central element of this configuration, the computer is connected via its audio card to the MIN IN A or B jacks (22) of the MON800. Additional sound modules, which are connected to the computer, for example, via MIDI, can be wired to the remaining inputs (depending on the respective connecting plugs). Playback devices (CD, MD, etc.) should be connected to the CD/TAPE IN jacks (21). Connect your main monitor speakers to the SPEAKERS OUT A jacks (18). Output B (17) is for a second pair of speakers. Often, smaller systems

are used as secondary speakers, so that it is possible to evaluate a mix over less powerful systems. A sub-woofer is an ideal complement to such a pair of speakers and should be connected to output C (17), since the levels of both outputs can be adjusted simultaneously.

If required, you can also connect a third pair of speakers, ideally with an adjustable amplifier stage, so that you can set the volume of the speaker pair C independently of the SPK LEVEL B + C control (5).

◆ The speaker outputs of the MINIMON provide line-level signals. Passive loudspeaker systems must be connected via an external integrated amplifier. Active loudspeakers have an amplifier built in and can therefore be connected directly to the MINIMON outputs.

The two headphones connectors (3) and (15) allow you to check your mix with a pair of headphones or route a monitor signal to one of the musicians. If you want to record several musicians, use the CUE OUT jack (19) for the connection of a headphones amp (e.g. BEHRINGER MINIAMP AMP800). In this way, each musician can set the volume of his headphones separately on the headphones amplifier.

Using a footswitch connected to the TB jack (16) you can activate the talk-back microphone and route the microphone signal to the monitor paths.

A recording device, such as a DAT or CD recorder, can be connected to the 2-TRACK OUT outputs (20).

## 4.2 Using the MINIMON for signal distribution in simple P.A. applications

The MINIMON can also be used for small P.A. systems, for example, in cafés and galleries. In this case, the three loudspeaker outputs (17) and (18) can be used for three pairs of speakers set up in several rooms. The inputs C and D (21) of the MINIMON can be connected directly to consumer equipment, such as CD/MD/cassette players or a radio tuner. If necessary, the built-in talk-back microphone (11) allows you to make announcements for your guests. With an additional set of headphones you can pre-listen to the input signals you wish to play back via the audio system. The following illustrations shows a possible wiring scheme.

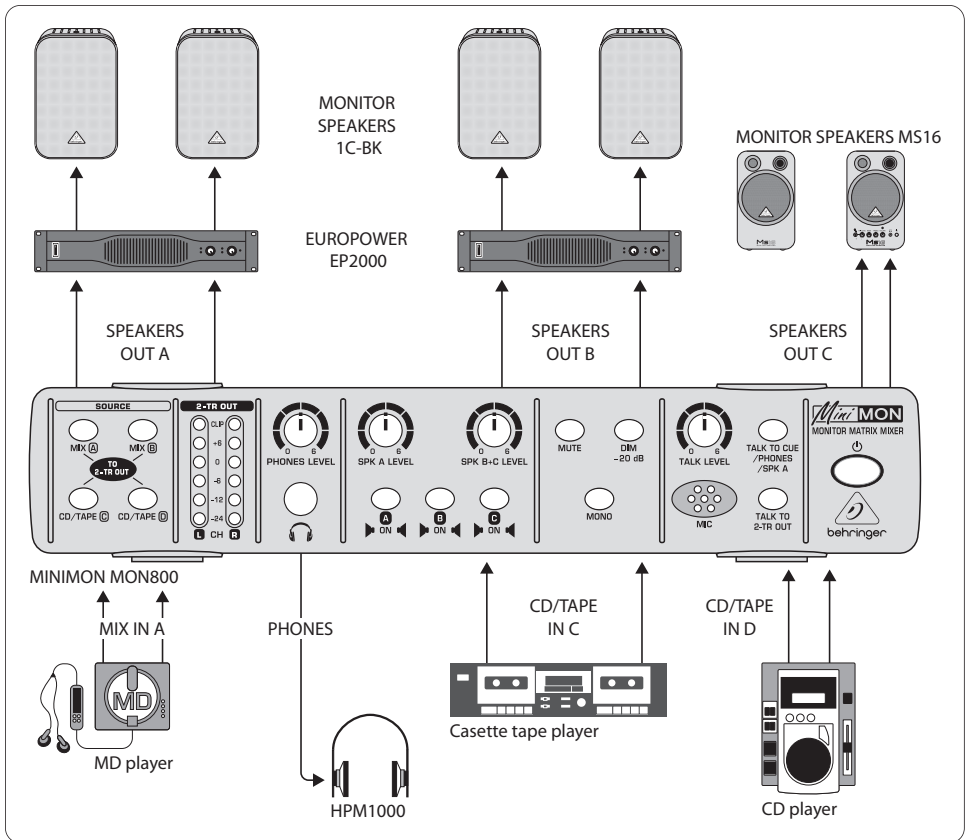

Fig. 4.2: Using the MON800 for signal distribution in small P.A. systems

## 5. Audio Connections

There are various ways to integrate the MON800 into your set-up. Depending on the application in question, you will need different sets of connecting cables. The cables to use are described below.

### 5.1 Connection with 1/4" or cinch cables

Please use standard 1/4" or cinch cables to connect the MINIMON to other equipment. These cables have a 1/4" or cinch connector at each end. Connect the inputs and outputs of the MON800 to the respective connectors of the other devices.

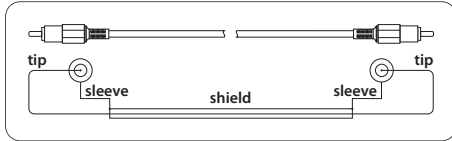

Fig. 5.1: Wiring diagram of a hi-fi cinch cable

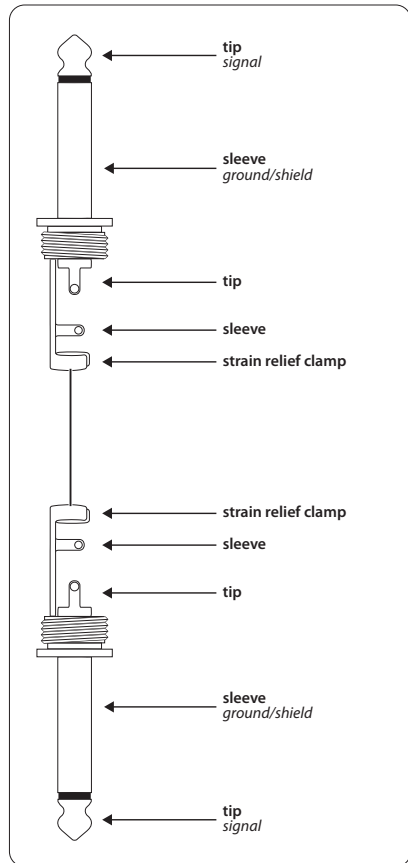

Fig. 5.2: Unbalanced cable with 1/4" TS connectors

### 5.2 Footswitch connection

The MINIMON features a jack for the connection of a footswitch. Here, you can connect any commercially available footswitch with a 1/4" TS connector. As some footswitch models on the market have a different polarity, please be sure to use one that is appropriately wired. The correct wiring is shown in the illustration below.

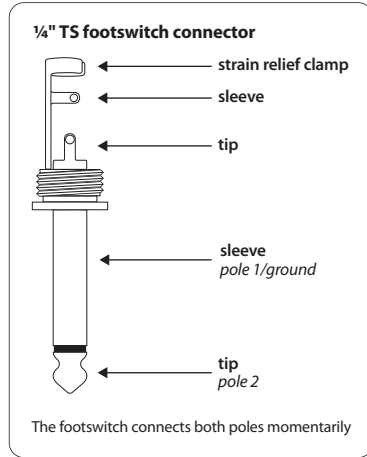

Fig. 5.3: Wiring of a 1/4" TS connector for footswitch connection

### 5.3 Headphones connection

The MINIMON has two jacks for headphones. Here, you can connect any standard pair of stereo headphones with a 1/4" TRS connector. For 3.5-mm plugs you need an appropriate adaptor. The correct wiring diagram is shown in the illustration below.

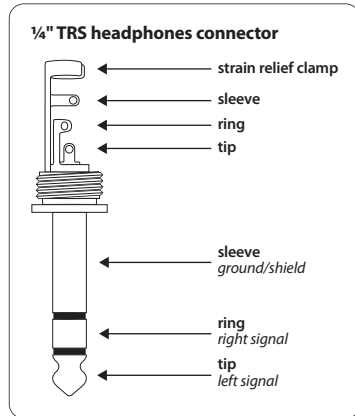

Fig. 5.4: Wiring of a 1/4" TRS headphones connector

## 6. Specifications

### Mix In A + B

Type	¼" TS connectors
Impedance	approx. 10 kΩ unbalanced approx. 20 kΩ balanced
Max. input level	15 dBu

### CD/Tape In C + D

Type	RCA connectors
Impedance	approx. 10 kΩ
Max. input level	15 dBu

### 2-Track Out A + B

Type	¼" TS connectors / RCA connectors
Impedance	approx. 150 Ω (TS), approx. 150 Ω (RCA)
Max. output level	15 dBu

### Cue Out

Type	¼" TS connectors
Impedance	min. 150 Ω
Max. output level	15 dBu

### Phones

Type	¼" TRS connector (on front/back)
Impedance	min. 100 Ω
Max. output level	10 dBu / 100 Ω (70 mW)

### Speakers Out A

Type	¼" TS connectors
Impedance	min. 150 Ω
Max. output level	15 dBu

### Speakers Out B + C

Type	RCA connectors
Impedance	min. 150 Ω
Max. output level	15 dBu

### System Specifications

Frequency response	10 Hz to 80 kHz, ±3 dB
Dynamic range	112 dB, 20 Hz to 20 kHz
Distortion (THD)	0,005% typ. @ +4 dBu
Crosstalk	-75 dB @ 1 kHz
Signal-to-noise ratio	102 dBu @ +4 dBu, A-weighted

### Power Supply

Mains connection	external power supply, 9 V~, 750 mA
------------------	----------------------------------------

### Mains Voltage

USA/Canada	120 V~, 60 Hz
U.K./Australia	240 V~, 50 Hz
China	220 V~, 50 Hz
Europe	230 V~, 50 Hz
Japan	100 V~, 50 - 60 Hz

Power consumption	approx. 6 W
-------------------	-------------

### Dimensions/Weight

DIMENSIONS (H x W x D)	approx. 48 x 120 x 242.6 mm
Weight	approx. 0.77 kg

BEHRINGER makes every effort to ensure the highest standard of quality. Necessary modifications are carried out without notice. Thus, the specifications and design of the device may differ from the information given in this manual.

## 7. Other Mini Products

The MINIMON belongs to the MINI suite of BEHRINGER products, which can operate together and are introduced below:

### MINIFEX FEX800

Ultra-compact 9.5" stereo multi-effects processor for studio and stage applications

- 16 awesome FX presets in 24-bit/48 kHz resolution including reverb, delay, chorus, flanger, phaser, rotary speaker, pitch shifter and multi-effects
- Intuitive FX Preset control with LED's indicating the selected program

### MINIAMP AMP800

Ultra-compact 9.5" headphones amplifier system for studio and stage applications

- 4 totally independent stereo high-power amplifier sections
- Highest sonic quality with virtually all types of headphones even at maximum volume

### MINIMIC MIC800

Ultra-compact 9.5" microphone modeling preamp for studio and stage applications

- High-end preamplifier for all microphone, instrument and line-level sources. Perfectly complements studio-grade condenser mics
- Ultra-flexible Preamp Modeling allows you to quickly optimize your recordings

### MINIFBQ FBQ800

Ultra-compact 9.5" graphic equalizer for studio and stage applications

- Revolutionary FBQ Feedback Detection System instantly reveals critical frequencies and can also be used as Audio Analyzer
- Additional Low Cut filter removes unwanted frequencies, e. g. floor rumble

### MINIMIX MIX800

Ultra-compact 9.5" karaoke machine for studio and stage applications

- Revolutionary Voice Canceller—effectively eliminates vocals from any stereo source while retaining most music elements
- Integrated digital echo/reverb processor in 24-bit/40 kHz resolution for ultimate vocal enhancement

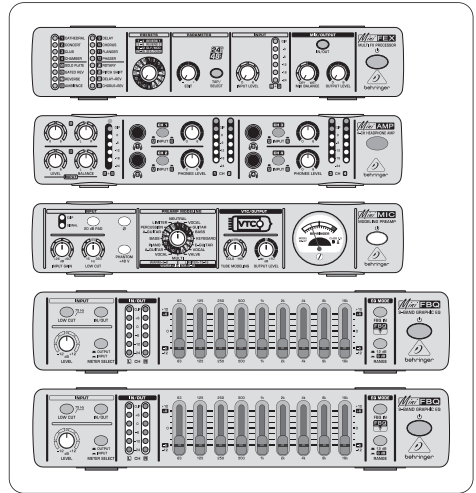

Fig. 7.1: MINI products stack on top of each other



We Hear You