



EMG PICKUPS

INSTALLATION INFORMATION

Models SPC, RPC, EXG

The SPC, RPC, and EXG are active EQ circuits. The SPC is a mid-range boost. The RPC is a low cut/high boost. The EXG is a low and high boost and is affectively a mid-range cut. The graphs to the right illustrate the effects of the controls. The thick line displays the effect with the control all the way up (clockwise). The flat line illustrates the effect with the control all the way down (counterclockwise) in the bypass mode. The controls are continuously variable from flat to maximum effect.

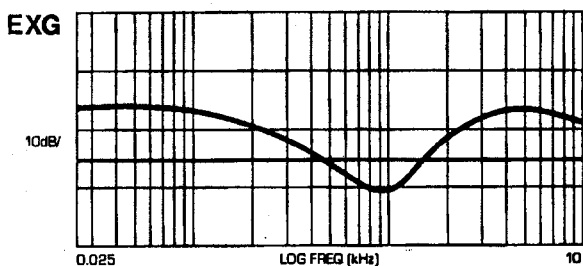
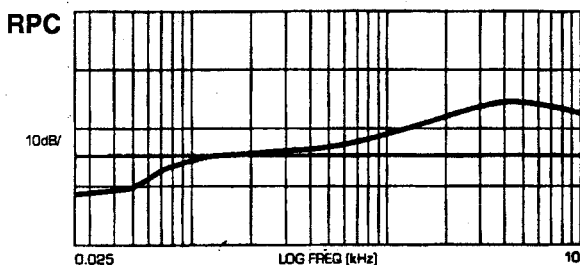
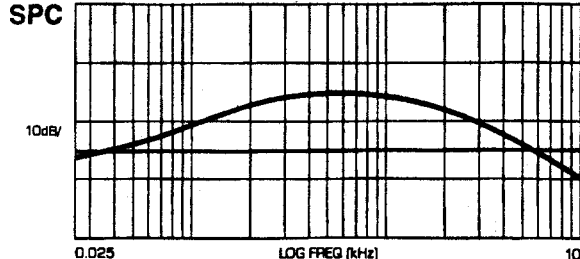

SPECIFICATIONS:

	SPC	RPC	EXG
Noise (dBV).....	-117	-118	-117
Output Impedance (Kohm).....	2	2	2
Current (Microamps).....	270	270	410
Battery Life (Hours).....	925	925	600

GENERAL INSTALLATION NOTES:

- 1) ONLY ONE BATTERY IS REQUIRED PER INSTRUMENT. ADDITIONAL ACTIVE COMPONENTS SUCH AS THE SPC, RPC, EXG, PI-2, PA-2, ETC. DO NOT REQUIRE AN ADDITIONAL BATTERY.
- 2) Use an alkaline battery, MN1604 or similar, for longest life.
- 3) The original EMG wiring must be altered. This is assuming that you already have EMG pickups in your instrument. If you are installing pickups along with an EQ circuit, please read both sets of instructions before you start. This should save you some steps.
- 4) Many diagrams are included with these instructions. Please find the diagram that most resembles your current set up and follow those instructions.

WARRANTY:

All EMG Pickups and accessories are warranted for a period of two years. This warranty does not cover failure due to improper installation, abuse or damage. Interface electronics (controls, etc.) are not covered under this warranty. If at any time a pickup fails to work, return it postage pre-paid with proof of purchase. If upon examination the pickup is determined to be defective, a replacement will be made at no charge. Warranty replacement products are covered by this same warranty. This warranty covers only those pickups and accessories sold by authorized EMG Dealers. This warranty is not transferable.

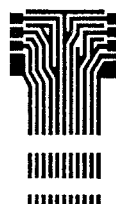

EMG
 P.O. BOX 4394
 SANTA ROSA, CA.
 95402 U.S.A.
 (707) 525-9941
 (707) 575-7046

3 Pickups with a 5-Way Switch and 1 EQ

PREPARATION

- 1) Unscrew the output jack plate and unsolder the three wires from the output jack.
- 2) Remove the strings.
- 3) Unscrew and remove the pickguard from the body with the pickups, controls, and selection switch intact.

Refer to Diagram #1

- 4) Unsolder and remove the white wire from lug 6 of the selector switch.
- 5) Cut and remove the jumper wire between lug 2 of tone 2 and lug 1 of tone 1.
- 6) Cut the thick silver ground buss wire off at tone 1 so that tone 2 is disconnected, and tone 1 is still connected to the volume control.
- 7) Remove tone 2 from pickguard.
- 8) Unsolder and remove the white wire between lug 2 of the volume and lug 3 of the jack.

INSTALLATION

Refer to Diagram #2

- 9) Solder a jumper wire between lugs 5 and 6 of the selection switch.
- 10) Install the EQ circuit into the pickguard.
- 11) Solder the black wire from the EQ to the casing of tone 1.
- 12) Solder the white wire from the EQ to lug 2 of the volume control.
- 13) Cut the red wire from the battery at the heat shrink covered connection and remove old heat shrink. Solder the red wire from the EQ with the red wires from the pickups and the battery. Cover this connection well with the new heat shrink provided.
- 14) Route the green wire from the EQ, the black wire from the volume control casing and the black wire from the battery clip through the hole between the control cavity and the jack plate cavity if necessary.
- 15) Connect the battery to the battery clip. Place it beneath tone control 1 and the volume control. Cut a small piece of foam to cover the bottom of the volume and tone control. Sandwich the battery between the foam on the controls and the back of the instrument cavity. Be sure the battery is well secured and that no harness connections are in contact with the battery casing.
- 16) Solder the green wire to lug 3 of the jack (tip).
- 17) Solder the black wire from the volume control casing to lug 2 of the jack (ring).
- 18) Solder the black wire from the battery clip to lug 1 of the jack (sleeve).
- 19) Reattach the pickguard and jack plate. Before restringing the guitar, test it by tapping on the pickups lightly with a metal object while plugged into an amp.

This completes the installation. If you have problems, contact the factory at the number provided on the front page of these instructions. Service is readily available.

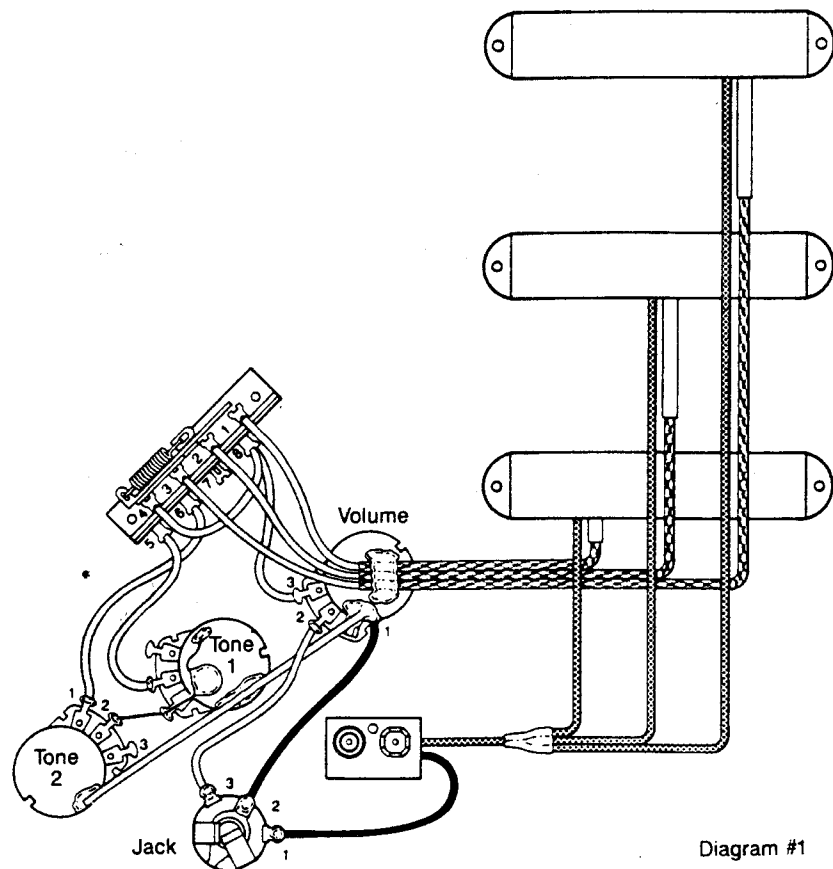
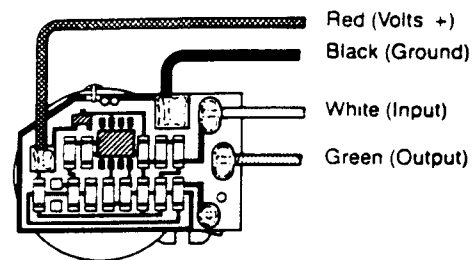

Diagram #1

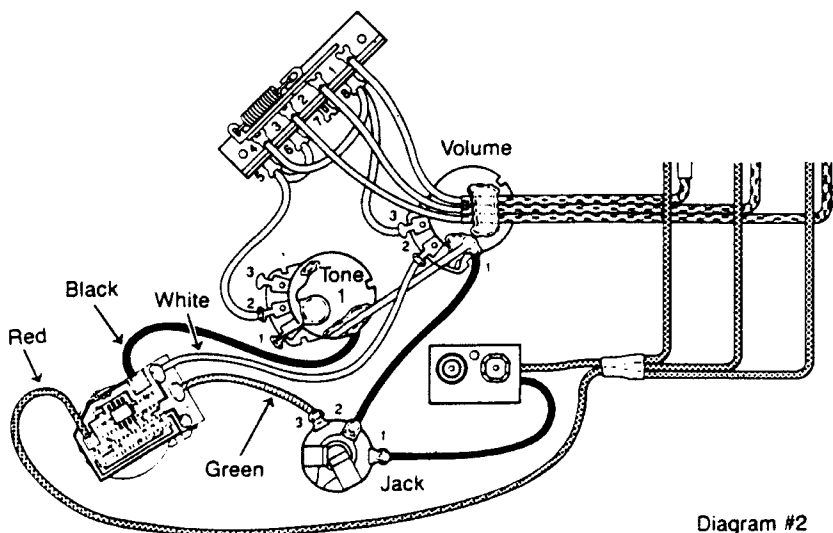

Diagram #2

3 Pickups, 5-Way Switch, 2 EQ

PREPARATION

- 1) Unscrew the output jack plate and unsolder the three wires from the output jack.
- 2) Remove the strings.
- 3) Unscrew and remove the pickguard from the body with the pickups, controls, and selection switch intact.

Refer to Diagram #1

- 4) Unsolder the two white wires on lugs 5 and 6 of the selector switch.
- 5) Unsolder the thick silver ground buss wire from the volume control casing.
- 6) Remove the two tone controls from the pickguard.
- 7) Unsolder and remove the white wire between lug 2 of the volume control and lug 3 of the jack.

INSTALLATION

It is recommended that when EQ controls follow each other in series operation, input and output gain be matched to avoid interstage distortion. We recommend the following combinations.

EQ #1	EQ #2
RPC	SPC
SPC	EXG
RPC	EXG

Refer to Diagram #3

- 8) Install the EQ circuits in the pickguard.
- 9) Solder the black wires of both the EQ circuits to the volume control casing.

- 10) Solder the white wire of EQ 1 to lug 2 of the volume control.
- 11) Solder the green wire of EQ 1 to the white wire of EQ 2 and cover this connection with heat shrink tubing.
- 12) Cut the red wire from the battery at the heat shrink covered connection and remove the old heat shrink. Solder the red wires of both EQ circuits with the red wires from the pickups and battery. Cover this connection with the new heat shrink tubing provided.
- 13) Route the green wire from EQ 2, the black wire from the volume control casing and the black wire from the battery clip through the hole between the control cavity and the jack plate cavity if necessary.
- 14) Connect the battery to the battery clip. Place it beneath one EQ circuit and the volume control. Cut a small piece of foam to cover the bottom of the volume and the EQ circuit. Sandwich the battery between the foam on the controls and the back of the instrument cavity. Be sure the battery is well secured and that no harness connections are in contact with the battery casing.
- 15) Solder the green wire from EQ 2 to lug 3 of the jack (tip).
- 16) Solder the black wire from the volume control casing to lug 2 of the jack (ring).
- 17) Solder the black wire from the battery clip to lug 1 of the jack (sleeve).
- 18) Reattach the pickguard and jack plate. Before restringing the guitar, test it by tapping on the pickups lightly with a metal object while plugged into an amp.

This completes the installation. If you have problems, contact the factory at the number provided on the front page of these instructions. Service is readily available.

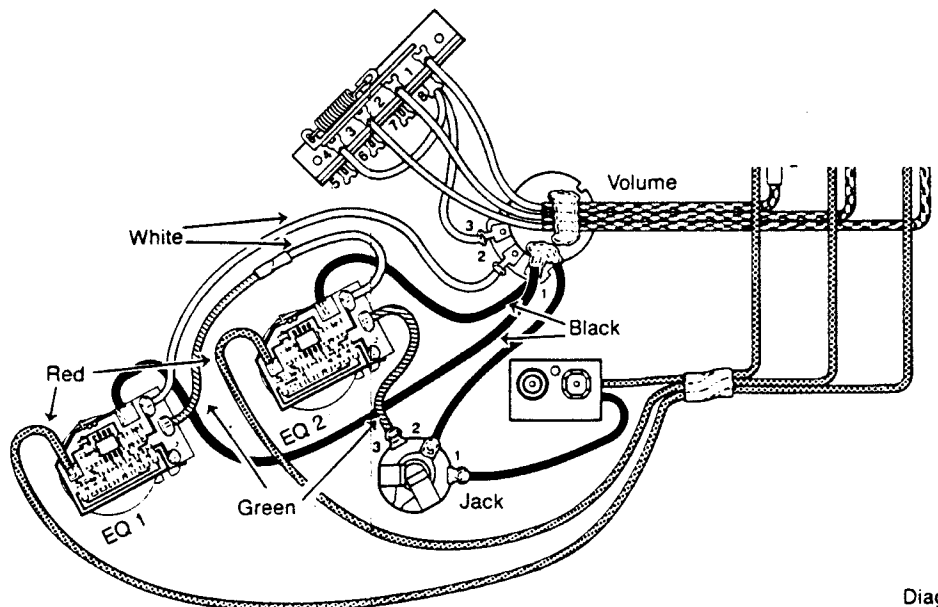
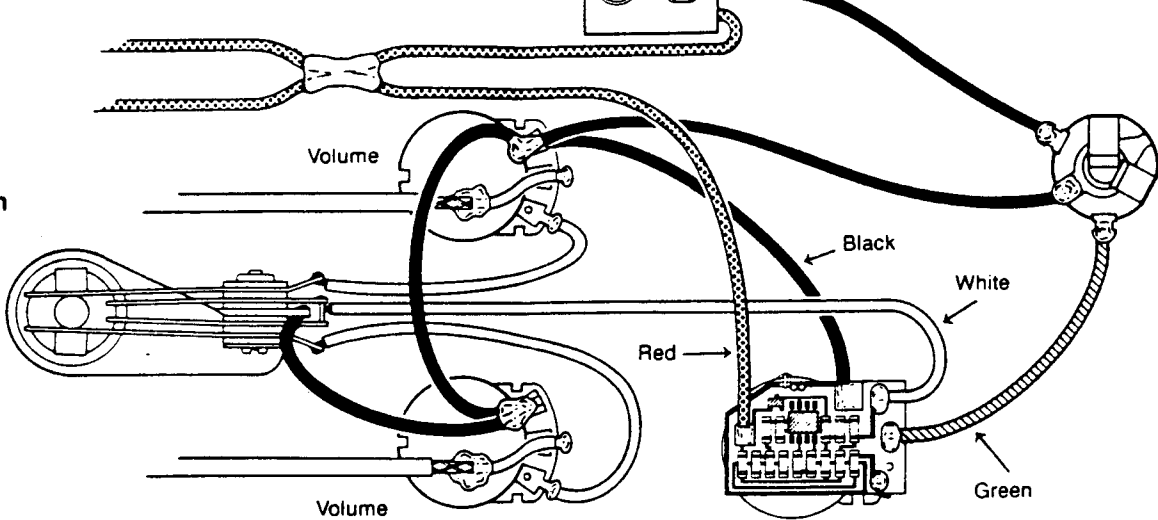
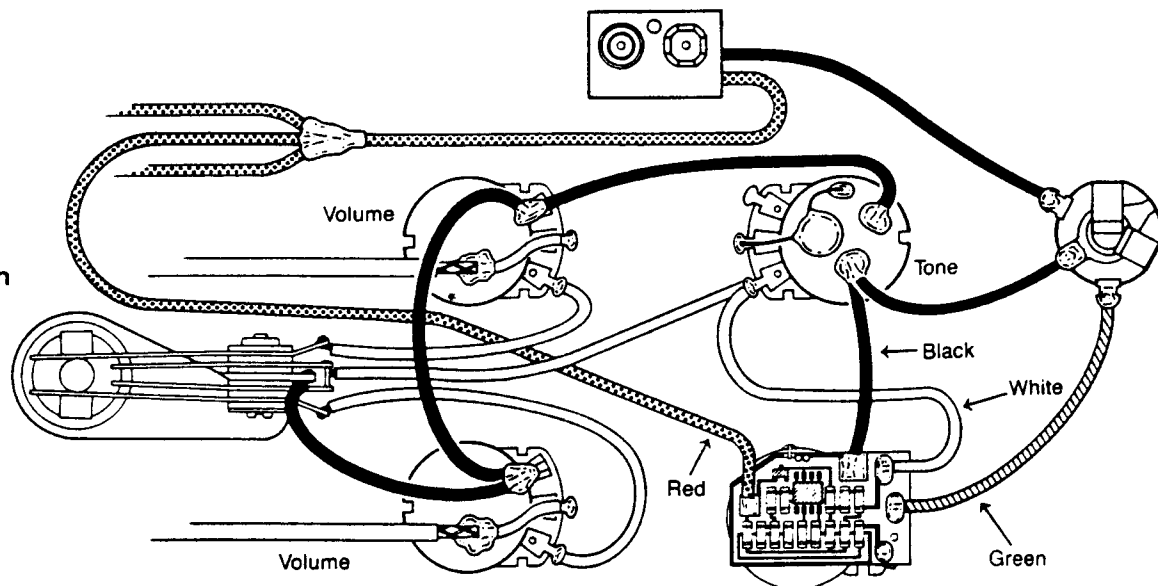

Diagram #3

2 Volume,
1 EQ,
with Switch



2 Volume,
1 Tone,
1 EQ,
with Switch



1 Volume,
1 EQ

