



xBrick Quad
16×8W RGBW
LED floodlight

Musikhaus Thomann
Thomann GmbH
Hans-Thomann-Straße 1
96138 Burgebrach
Germany
Telephone: +49 (0) 9546 9223-0
E-mail: info@thomann.de
Internet: www.thomann.de

09.03.2017, ID: 385641

Table of contents

1	General notes	5
	1.1 Further information.....	6
	1.2 Notational conventions.....	7
	1.3 Symbols and signal words.....	8
2	Safety instructions	11
3	Features	16
4	Installation	17
5	Starting up	21
6	Connections and controls	24
7	Operating	31
	7.1 Operating mode 'Manual'.....	32
	7.2 Operating mode 'Auto Run Mode'.....	35
	7.3 Operating mode 'Sound Mode'.....	36
	7.4 Operating mode 'DMX'.....	36
	7.5 Operating mode 'Slave'.....	47

7.6	Operating mode 'Static Colour'.....	47
7.7	Menu overview.....	49
7.8	Checking the operating temperature.....	54
7.9	Reset to factory defaults.....	54
8	Technical specifications.....	55
9	Plug and connection assignments.....	56
10	Troubleshooting.....	57
11	Cleaning.....	59
12	Protecting the environment.....	60

1 General notes

This manual contains important instructions for the safe operation of the unit. Read and follow the safety instructions and all other instructions. Keep the manual for future reference. Make sure that it is available to all those using the device. If you sell the unit please make sure that the buyer also receives this manual.

Our products are subject to a process of continuous development. Thus, they are subject to change.

1.1 Further information

On our website (www.thomann.de) you will find lots of further information and details on the following points:

Download	This manual is also available as PDF file for you to download.
Keyword search	Use the search function in the electronic version to find the topics of interest for you quickly.
Online guides	Our online guides provide detailed information on technical basics and terms.
Personal consultation	For personal consultation please contact our technical hotline.
Service	If you have any problems with the device the customer service will gladly assist you.

1.2 Notational conventions

This manual uses the following notational conventions:

Letterings

The letterings for connectors and controls are marked by square brackets and italics.

Examples: *[VOLUME]* control, *[Mono]* button.

Displays

Texts and values displayed on the device are marked by quotation marks and italics.

Examples: *'24ch'*, *'OFF'*.

Instructions



The individual steps of an instruction are numbered consecutively. The result of a step is indented and highlighted by an arrow.

Example:

- 1.** ▶ Switch on the device.
- 2.** ▶ Press *[Auto]*.
⇒ Automatic operation is started.
- 3.** ▶ Switch off the device.

1.3 Symbols and signal words

In this section you will find an overview of the meaning of symbols and signal words that are used in this manual.

Signal word	Meaning
DANGER!	This combination of symbol and signal word indicates an immediate dangerous situation that will result in death or serious injury if it is not avoided.
WARNING!	This combination of symbol and signal word indicates a possible dangerous situation that can result in death or serious injury if it is not avoided.
NOTICE!	This combination of symbol and signal word indicates a possible dangerous situation that can result in material and environmental damage if it is not avoided.
Warning signs	Type of danger
	Warning – high-voltage.
	Warning – suspended load.

Warning signs	Type of danger
	Warning – danger zone.

2 Safety instructions

Intended use

This device is intended to be used as an electronic illumination effect using LED technics. The device is designed for professional use and is not suitable for use in households. Use the device only as described in this user manual. Any other use or use under other operating conditions is considered to be improper and may result in personal injury or property damage. No liability will be assumed for damages resulting from improper use.

This device may be used only by persons with sufficient physical, sensorial, and intellectual abilities and having corresponding knowledge and experience. Other persons may use this device only if they are supervised or instructed by a person who is responsible for their safety.

Safety



DANGER!

Danger for children

Ensure that plastic bags, packaging, etc. are disposed of properly and are not within reach of babies and young children. Choking hazard!

Ensure that children do not detach any small parts (e.g. knobs or the like) from the unit. They could swallow the pieces and choke!

Never let children unattended use electrical devices.



DANGER!

Electric shock caused by high voltages inside

Within the device there are areas where high voltages may be present. Never remove any covers.

There are no user-serviceable parts inside.

Do not use the device if covers, protectors or optical components are missing or damaged.



DANGER!

Electric shock caused by short-circuit

Always use proper ready-made insulated mains cabling (power cord) with a protective contact plug. Do not modify the mains cable or the plug. Failure to do so could result in electric shock/death or fire. If in doubt, seek advice from a registered electrician.



WARNING!

Eye damage caused by high light intensity

Never look directly into the light source.



WARNING!

Risk of epileptic shock

Strobe lighting can trigger seizures in photosensitive epilepsy. Sensitive persons should avoid looking at strobe lights.



NOTICE!

Risk of fire

Do not cover the device nor any ventilation slots. Do not place the device near any direct heat source. Keep the device away from naked flames.



NOTICE!

Operating conditions

This device has been designed for indoor use only. To prevent damage, never expose the device to any liquid or moisture. Avoid direct sunlight, heavy dirt, and strong vibrations.



NOTICE!

Power supply

Before connecting the device, ensure that the input voltage (AC outlet) matches the voltage rating of the device and that the AC outlet is protected by a residual current circuit breaker. Failure to do so could result in damage to the device and possibly injure the user.

Unplug the device before electrical storms occur and when it is unused for long periods of time to reduce the risk of electric shock or fire.

3 Features

The LED floodlight is particularly suitable for professional lighting tasks, for example at events, on rock stages and in theatres and musicals. The device is characterised by excellent colour mixing properties and very high light output.

Special features of the device:

- 16 quad-colour LEDs (red, green, blue, white), 8 W each
- Control via DMX (five different modes), via buttons and display on the unit as well as via an optionally available IR remote control
- 23 preprogrammed automatic shows
- Sound control
- Master / Slave mode
- Robust metal housing

4 Installation

Unpack and carefully check that there is no transportation damage before using the unit. Keep the equipment packaging. To fully protect the device against vibration, dust and moisture during transportation or storage use the original packaging or your own packaging material suitable for transport or storage, respectively.



WARNING!

Risk of injury caused by falling objects

Make sure that the installation complies with the standards and rules that apply in your country. Always secure the device with a secondary safety attachment, such as a safety cable or a safety chain.



NOTICE!

Risk of overheating

Always ensure sufficient ventilation.

The ambient temperature must always be below 40 °C (104 °F).



NOTICE!

Use of stands

When mounting the device onto a stand, ensure that the stand is in a safe and stable position and that the weight of the device does not exceed the maximum permissible load capacity of the stand.

**NOTICE!****Possible data transmission errors**

For error-free operation make use of dedicated DMX cables and do not use ordinary microphone cables.

Never connect the DMX input or output to audio devices such as mixers or amplifiers.

Mounting options

You can install the unit in hanging or standing position. When in use, the device must always be attached to a solid surface or an approved truss. Use the openings provided on the two-piece bracket for attaching.

Always work from a stable platform whenever installing, moving or servicing the unit. In doing so, the area underneath the unit must be cordoned off.

Additionally secure the device by a safety-rope against falling.



Please note that this device must not be connected to a dimmer.

5 Starting up

Establish all connections as long as the unit is switched off. Use the shortest possible high-quality cables for all connections.

Connections in DMX mode

Connect the DMX input of the device to the DMX output of a DMX controller or another DMX device. Connect the output of the first DMX device to the input of the second one, and so on to form a daisy chain. Always ensure that the output of the last DMX device in the daisy chain is terminated with a resistor ($110\ \Omega$, $\frac{1}{4}\text{ W}$).

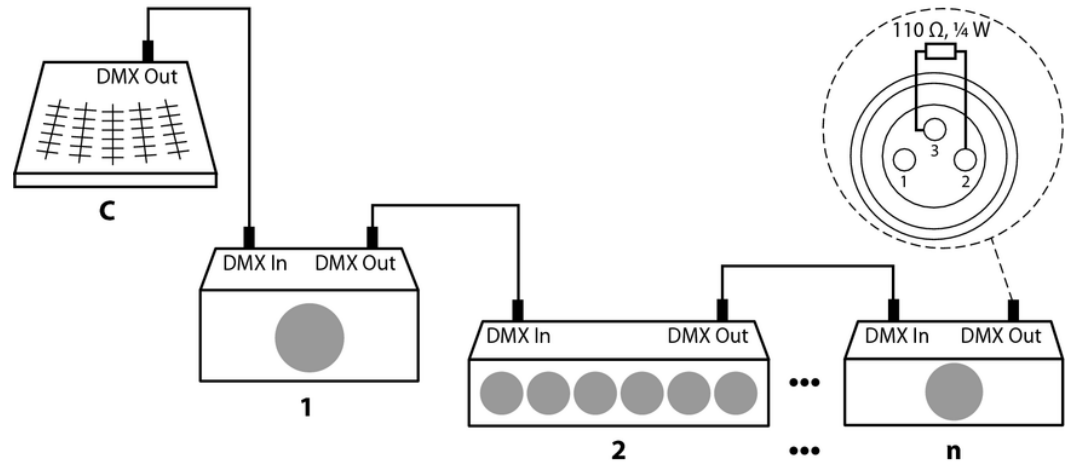

Connections in master/slave mode

When you configure a group of devices in master/slave mode, the first unit will control the other units for an automatic, sound-activated, synchronized show. This function is ideal when you want to start a show immediately. Connect the DMX output of the master device to the DMX input of the first slave device. Then connect the DMX output of the first slave device to the DMX input of the second slave device and so on.

6 Connections and controls

Rear panel

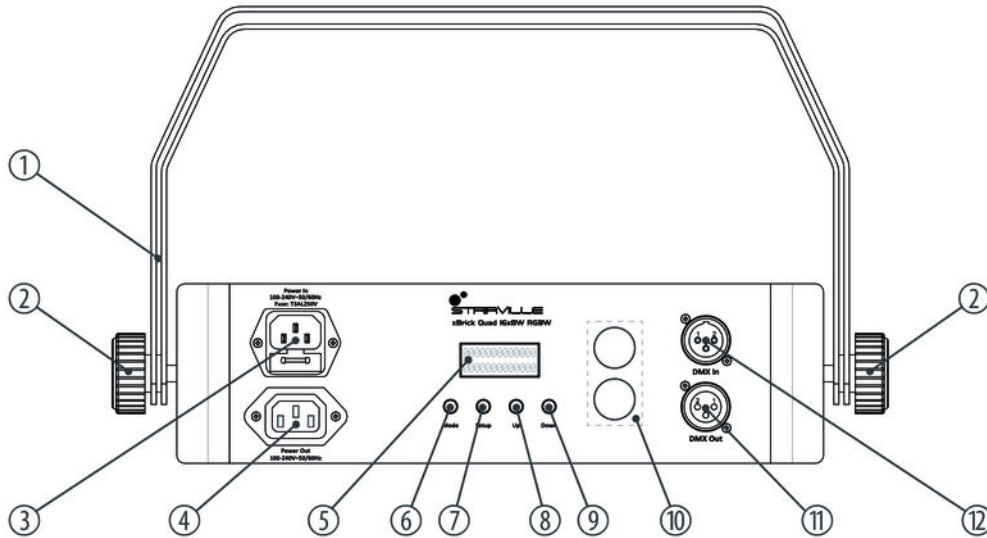

1	Bracket for floor placement or hanging.
2	Locking screws for the mounting brackets.
3	<i>[Power In]</i> Mains chassis plug with fuse holder.
4	<i>[Power Out]</i> Output socket to power another device with mains voltage.
5	Display.
6	<i>[Mode]</i> Activates the main menu, saves changes.
7	<i>[Setup]</i> Selects an option of the respective operating mode.
8	<i>[Up]</i> Increases the displayed value by one.

9	<i>[Down]</i> Decreases the displayed value by one.
10	Openings for fastening a safety rope.
11	<i>[DMX Out]</i> DMX output.
12	<i>[DMX In]</i> DMX input.

Front panel

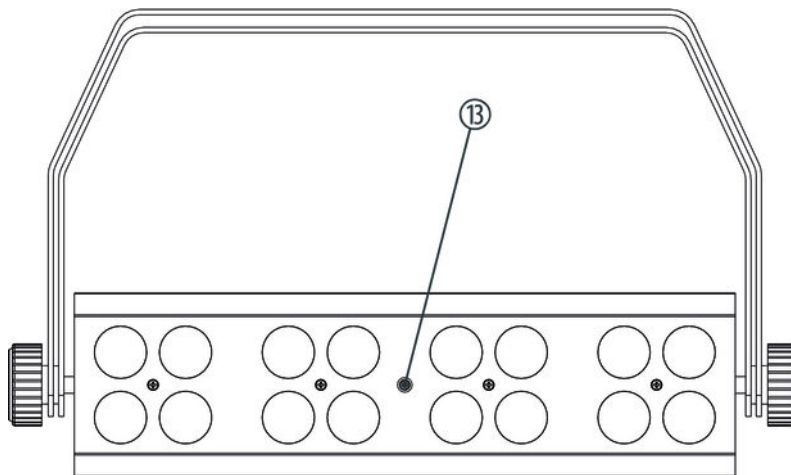

13 Infrared sensor for optionally available remote control.

xBrick Quad 16x8W RGBW

Remote control (optional)

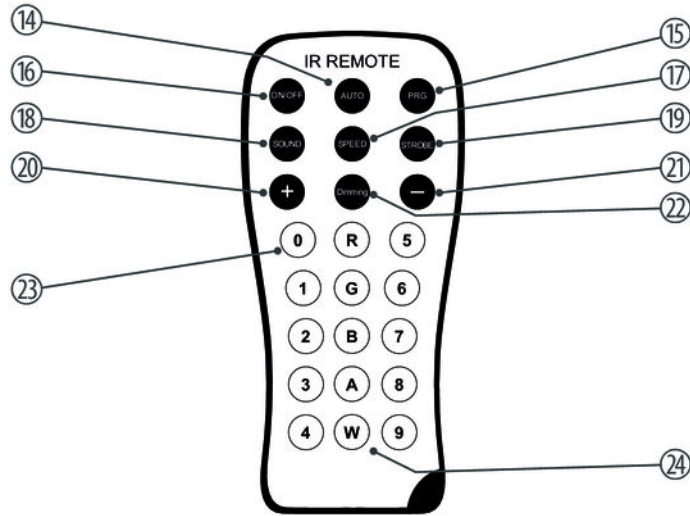

14	<i>[AUTO]</i> Activates the 'Automatic' mode.
15	<i>[PRG]</i> Activates the operating mode 'Preprogrammed automatic show'. Select the desired programme with the buttons <i>[+]</i> and <i>[-]</i> .
16	<i>[ON/OFF]</i> Activates / deactivates the device.
17	<i>[SPEED]</i> Activates the setting mode for the programme speed. Adjust the speed using the buttons <i>[+]</i> and <i>[-]</i> .
18	<i>[SOUND]</i> Activates the sound-controlled mode.
19	<i>[STROBE]</i> Turns the strobe effect on / off.
20	<i>[+]</i> Increases the set value.

21	<i>[-]</i> Decreases the set value.
22	<i>[Dimming]</i> Enables the dimmer function.
23	<i>[0 ... 9]</i> Numeric buttons for direct selection of a fixed colour.
24	<i>[R], [G], [B], [A], [W]</i> Buttons to select a colour tone for the dimmer mode.

7 Operating

Connect the device to the power supply to start operation. After a few seconds, the display indicates that a reset is in progress. The device is then ready for use.

Press *[Mode]* to activate the main menu and select an operating mode. Use *[Setup]* to select further options. Use *[Up]* and *[Down]* to change the respectively indicated value. The unit instantly applies the displayed value, you don't need to push a button for confirmation.

If you don't press any button for about 20 seconds, the current setting will be automatically applied and the display turns off. The set values are retained as long as the device is connected to the mains power supply.

7.1 Operating mode 'Manual'

This operating mode can only be activated when the unit is operating in stand alone mode or as master in a master / slave combination. This setting is only relevant if the device is not controlled via DMX.

1. ➤ Press *[Mode]*, use *[Up]* and *[Down]* to select the menu option 'Program Mode' and confirm with *[Setup]*.
2. ➤ Use *[Up]* and *[Down]* to select the desired programme (01 ... 23) and confirm with *[Setup]*.

Settings for programme 01

When you have selected programme 01, you can use *[Up]* and *[Down]* to select one of 15 static colour settings for all LEDs, see the following chart.

Colour	Display
Cyan	'00'
Purple	'01'
Pink	'02'
Orange	'03'
Cold white	'04'
Bright red	'05'
Bright green	'06'
Bright blue	'07'
Yellow	'08'
Warm white	'09'

Colour	Display
Red	'10'
Green	'11'
Blue	'12'
Amber	'13'
All	'14'
Blackout	'15'

Settings for programmes 02 ... 23

When you have selected one of programmes 02 ... 23 you can adjust the following settings:

1. ➤ After selecting the programme, press again *[Setup]* and adjust the programme speed with *[Up]* and *[Down]* in a range from '001' ... '100' (slow ... fast).
2. ➤ Press again *[Setup]* and adjust the frequency of the strobe effect with *[Up]* and *[Down]* in a range from '001' ... '100' (slow ... fast).

7.2 Operating mode 'Auto Run Mode'

A preprogrammed automatic show can only be activated when the unit is operating in stand-alone mode or as master in a master / slave combination. This setting is only relevant if the device is not controlled via DMX.

1. ➤ Press *[Mode]*, use *[Up]* and *[Down]* to select the menu option 'Auto Run Mode' and confirm with *[Setup]*.
2. ➤ Adjust the programme speed with *[Up]* and *[Down]* in a range from '001' ... '100' (slow ... fast) and confirm with *[Setup]*.
3. ➤ Adjust the frequency of the strobe effect with *[Up]* and *[Down]* in a range from '001' ... '100' (slow ... fast) and confirm with *[Setup]*.
4. ➤ Set the number of runs with *[Up]* and *[Down]* in a range from '001' ... '100' (slow ... fast) and confirm with *[Setup]* to quit the menu.

7.3 Operating mode 'Sound Mode'

This setting is only relevant if the device is working as Slave in a Master / Slave configuration and is not controlled via DMX. In this operating mode, the device responds to acoustic pulses which are recorded by the integrated microphone.

1. ➤ Press *[Mode]*, use *[Up]* and *[Down]* to select the menu option 'Sound Mode' and confirm with *[Setup]*.
2. ➤ Set the sensitivity of the built-in microphone with *[Up]* and *[Down]* in a range from '00' ... '31' (minimum ... maximum sensitivity) and confirm with *[Setup]*.
3. ➤ Use *[Up]* and *[Down]* to select one of the options 'Scene 1' for slow or 'Scene 2' for fast transitions between the programmed shows and confirm with *[Setup]* to quit the menu.

7.4 Operating mode 'DMX'

This setting is only relevant if the device is controlled via a DMX controller.

1. ➤ Press *[Mode]*, use *[Up]* and *[Down]* to select the menu option 'DMX 512 Mode' and confirm with *[Setup]*.
2. ➤ Use *[Up]* and *[Down]* to assign a DMX address in the range from '001' ... '512' to the device and confirm with *[Setup]*.
3. ➤ Use *[Up]* and *[Down]* to select the desired DMX mode:

Mode	Highest possible DMX address
4-channel	509
6-channel	507
8-channel	505
16-channel	497
18-channel	495

4. ➤ Confirm with *[Setup]*.

7.4.1 Functions in 4-channel DMX mode

Channel	Value	Function
1	0...255	Intensity red (0 % to 100 %)
2	0...255	Intensity green (0 % to 100 %)
3	0...255	Intensity blue (0 % to 100 %)
4	0...255	Intensity white (0 % to 100 %)

7.4.2 Functions in 6-channel DMX mode

Channel	Value	Function
1	0...255	Intensity red (0 % to 100 %)
2	0...255	Intensity green (0 % to 100 %)
3	0...255	Intensity blue (0 % to 100 %)

Channel	Value	Function
4	0...255	Intensity white (0 % to 100 %)
5	0...255	Dimmer (0 % to 100 %)
6	0...255	Stroboscope effect (0 % to 100 %)

7.4.3 Functions in 8-channel DMX mode

Channel	Value	Function
1	0 ... 255	Intensity red (0 % to 100 %), if channel 7 = 0 ... 4
2	0 ... 255	Intensity green (0 % to 100 %), if channel 7 = 0 ... 4
3	0 ... 255	Intensity blue (0 % to 100 %), if channel 7 = 0 ... 4
4	0 ... 255	Intensity white (0 % to 100 %), if channel 7 = 0 ... 4
5	0 ... 255	Dimmer (0 % to 100 %), if channel 7 = 5 ... 233

Channel	Value	Function
6	0 ... 255	Stroboscope effect (0 % to 100 %), if channel 7 = 5 ... 233
7	0 ... 4	No function
	5 ... 9	Intensity cyan (0 % to 100 %)
	10 ... 14	Intensity purple (0 % to 100 %)
	15 ... 19	Intensity pink (0 % to 100 %)
	20 ... 24	Intensity orange (0 % to 100 %)
	25 ... 29	Intensity cold white (0 % to 100 %)
	30 ... 34	Intensity bright red (0 % to 100 %)
	35 ... 39	Intensity bright green (0 % to 100 %)
	40 ... 44	Intensity bright blue (0 % to 100 %)
	45 ... 49	Intensity yellow (0 % to 100 %)
	50 ... 54	Intensity warm white (0 % to 100 %)
	55 ... 59	Intensity red (0 % to 100 %)

Channel	Value	Function
	60 ... 64	Intensity green (0 % to 100 %)
	65 ... 69	Intensity blue (0 % to 100 %)
	70 ... 74	Intensity amber (0 % to 100 %)
	75 ... 79	All
	80 ... 86	Programme 02
	87 ... 93	Programme 03
	99 ... 100	Programme 04
	101 ... 107	Programme 05
	108 ... 114	Programme 06
	115 ... 121	Programme 07
	122 ... 128	Programme 08
	129 ... 135	Programme 09
	136 ... 142	Programme 10

Channel	Value	Function
	143 ... 149	Programme 11
	150 ... 156	Programme 12
	157 ... 163	Programme 13
	164 ... 170	Programme 14
	171 ... 177	Programme 15
	178 ... 184	Programme 16
	185 ... 191	Programme 17
	192 ... 198	Programme 18
	199 ... 205	Programme 19
	206 ... 212	Programme 20
	213 ... 219	Programme 21
	220 ... 226	Programme 22
	227 ... 233	Programme 23

Channel	Value	Function
	234 ... 240	Sound-controlled operation, slow transition programmes 02 to 23
	241 ... 255	Sound-controlled operation, fast transition programmes 02 to 23
8		No function, if channel 7 = 0 ... 79
	0 ... 255	Programme speed, if channel 7 = 80 ... 233
	0 ... 255	Microphone sensitivity, if channel 7 = 234 ... 255

7.4.4 Functions in 16-channel DMX mode

Channel	Value	Function
1	0 ... 255	Intensity red (0 % to 100 %), segment 1
2	0 ... 255	Intensity green (0 % to 100 %), segment 1

Channel	Value	Function
3	0 ... 255	Intensity blue (0 % to 100 %), segment 1
4	0 ... 255	Intensity white (0 % to 100 %), segment 1
5	0 ... 255	Intensity red (0 % to 100 %), segment 2
6	0 ... 255	Intensity green (0 % to 100 %), segment 2
7	0 ... 255	Intensity blue (0 % to 100 %), segment 2
8	0 ... 255	Intensity white (0 % to 100 %), segment 2
9	0 ... 255	Intensity red (0 % to 100 %), segment 3
10	0 ... 255	Intensity green (0 % to 100 %), segment 3
11	0 ... 255	Intensity blue (0 % to 100 %), segment 3
12	0 ... 255	Intensity white (0 % to 100 %), segment 3
13	0 ... 255	Intensity red (0 % to 100 %), segment 4
14	0 ... 255	Intensity green (0 % to 100 %), segment 4

Channel	Value	Function
15	0 ... 255	Intensity blue (0 % to 100 %), segment 4
16	0 ... 255	Intensity white (0 % to 100 %), segment 4

7.4.5 Functions in 18-channel DMX mode

Channel	Value	Function
1	0 ... 255	Intensity red (0 % to 100 %), segment 1
2	0 ... 255	Intensity green (0 % to 100 %), segment 1
3	0 ... 255	Intensity blue (0 % to 100 %), segment 1
4	0 ... 255	Intensity white (0 % to 100 %), segment 1
5	0 ... 255	Intensity red (0 % to 100 %), segment 2
6	0 ... 255	Intensity green (0 % to 100 %), segment 2

Channel	Value	Function
7	0 ... 255	Intensity blue (0 % to 100 %), segment 2
8	0 ... 255	Intensity white (0 % to 100 %), segment 2
9	0 ... 255	Intensity red (0 % to 100 %), segment 3
10	0 ... 255	Intensity green (0 % to 100 %), segment 3
11	0 ... 255	Intensity blue (0 % to 100 %), segment 3
12	0 ... 255	Intensity white (0 % to 100 %), segment 3
13	0 ... 255	Intensity red (0 % to 100 %), segment 4
14	0 ... 255	Intensity green (0 % to 100 %), segment 4
15	0 ... 255	Intensity blue (0 % to 100 %), segment 4
16	0 ... 255	Intensity white (0 % to 100 %), segment 4
17	0 ... 255	Dimmer (0 % to 100 %)
18	0 ... 255	Stroboscope effect (0 % to 100 %)

7.5 Operating mode 'Slave'

This setting is only relevant if the device is working as Slave in a Master / Slave configuration and is not controlled via DMX. To activate the operating mode, repeatedly press *[Mode]* until the display shows 'Slave'.

7.6 Operating mode 'Static Colour'

This setting is only relevant if the device is working in Stand Alone mode and is not controlled via DMX. In this mode you have the option to select a solid colour for continuous operation and to set the flash frequency for all LEDs.

1. ➤ Press *[Mode]*, use *[Up]* and *[Down]* to select the menu option 'Static Colour Mode' and confirm with *[Setup]*.
2. ➤ Use *[Up]* and *[Down]* to set the intensity for the red colour in a range from '000' ... '255' (bright ... dark) and confirm with *[Setup]*.
3. ➤ Use *[Up]* and *[Down]* to set the intensity for the green colour in a range from '000' ... '255' (bright ... dark) and confirm with *[Setup]*.

- 4.** ▶ Use *[Up]* and *[Down]* to set the intensity for the blue colour in a range from '000' ... '255' (bright ... dark) and confirm with *[Setup]*.
- 5.** ▶ Use *[Up]* and *[Down]* to set the intensity for the white colour in a range from '000' ... '255' (bright ... dark) and confirm with *[Setup]*.
- 6.** ▶ Use *[Up]* and *[Down]* to set the flash frequency of the LEDs in a range from '000' ... '255' (slow ... fast) and confirm with *[Setup]* to quit the menu.

7.7 Menu overview

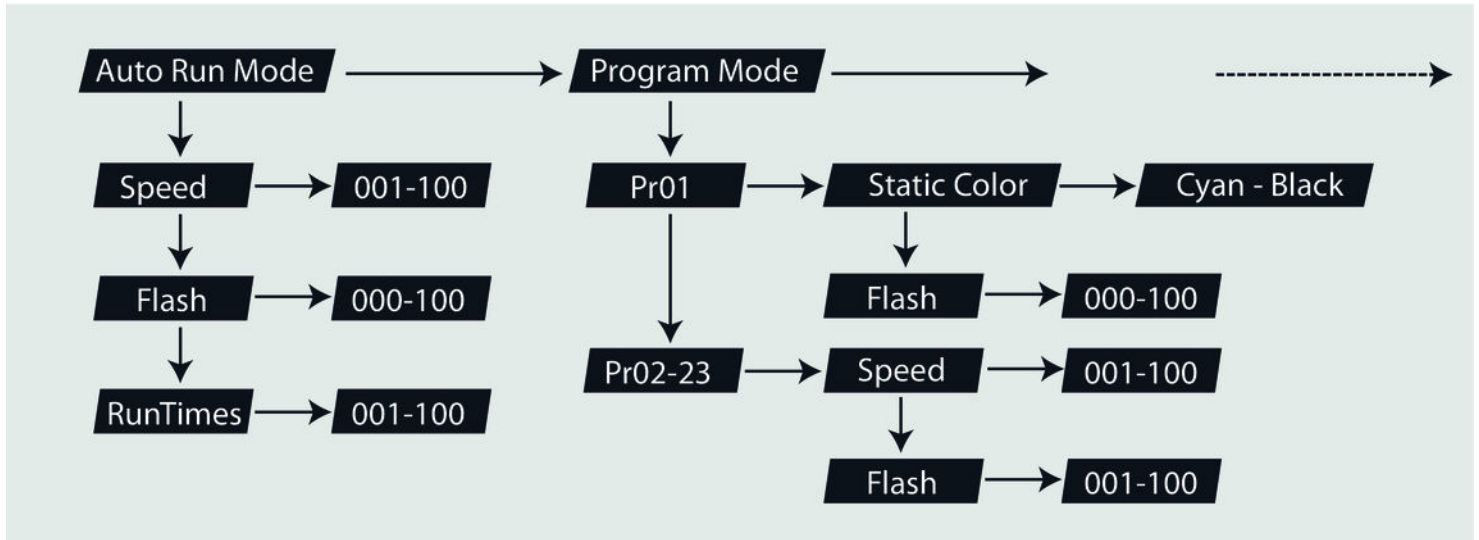

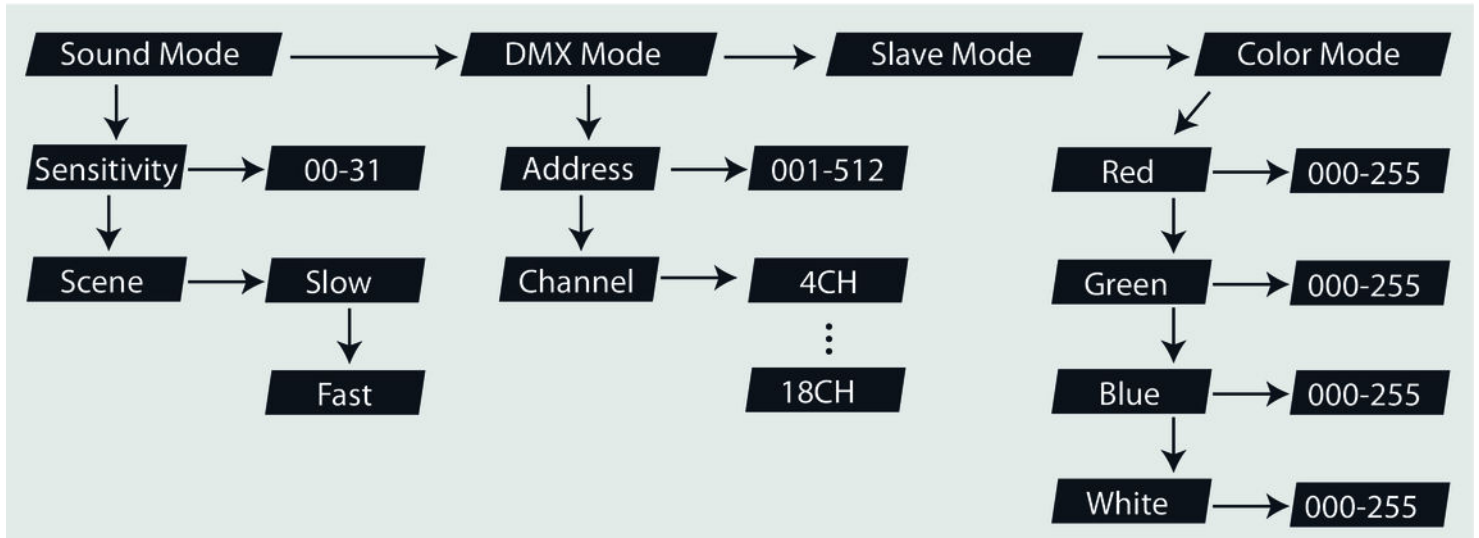

7.7.1 Control via optional remote

The device can only be remote controlled if it's neither working in a Master / Slave configuration nor DMX-controlled.

Switching on / off

Use *[ON/OFF]* to switch the device on or off.

Operating mode 'Automatic'

Press *[AUTO]*. Playback of programmes 'Pr.02' to 'Pr.23' starts automatically.

Operating mode 'Preprogrammed Automatic Show'

Press *[PRG]*. Use *[+]* and *[-]* to select a value between 'Pr.01' and 'Pr.23'.

In 'Preprogrammed Automatic Show' mode you can turn on a Strobe effect. Therefore press *[STROBE]* and then use *[+]* and *[-]* to select a value between '001' (slow) and '100' (fast). Press *[STROBE]* again to turn the Strobe effect off.

You can adjust the process speed for programmes 'Pr.02' and 'Pr.23'. Therefore press *[SPEED]* and then use *[+]* and *[-]* to select a value between '001' (slow) and '100' (fast).

Sound control

Press *[SOUND]*. This activates a sound-controlled automatic show.

Use *[+]* and *[-]* to select the sensitivity for the sound control in a range from 'SV.00' to 'SV.31' and confirm with *[Setup]*.

Use *[Up]* and *[Down]* to select one of the options 'Scene 1' for fast or 'Scene 2' slow transitions between the programmed shows.

Dimming

Press *[Dimming]* to adjust the brightness of the individual basic colours. Press *[R]* (red), *[G]* (green) or *[B]* (blue) and then use *[+]* and *[-]* to select a value between 0 and 255.

Colour selection

In every operating mode you can use the colour buttons to directly select a colour. The following assignment applies:

Button	Colour	Button	Colour	Button	Colour
0	Cyan	5	Bright red	R	Red
1	Purple	6	Bright green	G	Green
2	Magenta	7	Bright blue	B	Blue
3	Orange	8	Yellow	A	Amber
4	Cold white	9	Warm white	W	White

Reset to factory defaults

Press *[OFF]* and then successively *[9]*, *[8]* and *[7]* to reset the device to its default settings.

7.8 Checking the operating temperature

To check the operating temperature, first turn the device off. Keep the button *[Mode]* pressed and switch the device on again. If the permissible operating temperature is exceeded, the display shows 'Tr:Er'.

In this case, switch the device off and let it cool down for some time.

7.9 Reset to factory defaults

To reset all values to their factory default settings press *[Mode]* and *[Setup]* simultaneously.

8 Technical specifications

LEDs	16 × 8 W RGBW
Number of DMX channels	4, 6, 8, 16, 18
Power consumption	125 W
Operating supply voltage	AC 240 V ~ 50 Hz
Fuse	5 mm × 20 mm, 3 A, 250 V, slow blow
Dimensions (W × H × D)	315 mm × 88 mm × 195 mm
Weight	4.3 kg

9 Plug and connection assignments

Introduction

This chapter will help you select the right cables and plugs to connect your valuable equipment so that a perfect light experience is guaranteed.

Please take our tips, because especially in 'Sound & Light' caution is indicated: Even if a plug fits into a socket, the result of an incorrect connection may be a destroyed DMX controller, a short circuit or 'just' a not working light show!

DMX connections



The unit offers a 3-pin XLR socket for DMX output and a 3-pin XLR plug for DMX input. Please refer to the drawing and table below for the pin assignment of a suitable XLR plug.

Pin	Configuration
1	Ground, shielding
2	Signal inverted (DMX-, 'cold signal')
3	Signal (DMX+, 'hot signal')

10 Troubleshooting



NOTICE!

Possible data transmission errors

For error-free operation make use of dedicated DMX cables and do not use ordinary microphone cables.

Never connect the DMX input or output to audio devices such as mixers or amplifiers.

In the following we list a few common problems that may occur during operation. We give you some suggestions for easy troubleshooting:

The device does not work, no light and the fan does not work.

1. ▶ Check whether the unit is connected to mains power.
2. ▶ Check the mains power fuse.

The device is not responding to DMX controller.

- 1.** ▶ Check the DMX connectors and cables for proper connection.
- 2.** ▶ Check the DMX address settings and polarity.
- 3.** ▶ Try to use another DMX controller.
- 4.** ▶ Check to see if the DMX cables run near or even alongside to high voltage cables that may cause damage or interference to DMX interface circuitry.

If the procedures recommended above do not succeed, please contact our Service Center. You can find the contact information at www.thomann.de.

11 Cleaning

Optical lenses

Clean the optical lenses, that are accessible from the outside, regularly in order to optimize the light output. The frequency of cleaning depends on the operating environment: wet, smoky or particularly dirty surroundings can cause more accumulation of dirt on the optics of the device.

- Clean with a soft cloth using our lamp and lens cleaner (item no. 280122).
- Always dry the parts carefully.

Fan grids

The fan grids of the device must be cleaned on a regular basis to remove dust and dirt. Before cleaning, switch off the device and disconnect AC-powered devices from the mains. Use a lint-free damp cloth for cleaning. Never use solvents or alcohol for cleaning.

12 Protecting the environment

Disposal of the packaging material



For the transport and protective packaging, environmentally friendly materials have been chosen that can be supplied to normal recycling.

Ensure that plastic bags, packaging, etc. are properly disposed of.

Do not just dispose these materials with your normal household waste, but make sure that they are fed to a recovery. Please follow the notes and markings on the packaging.

Disposal of batteries



Batteries must not be disposed of as domestic waste or thrown into fire. Dispose of the batteries according to national or local regulations regarding hazardous waste. To protect the environment, dispose of empty batteries at your retail store or at appropriate collection sites.

Disposal of your old device



This product is subject to the European Waste Electrical and Electronic Equipment Directive (WEEE). Do not dispose with your normal household waste.

Dispose this device through an approved waste disposal firm or through your local waste facility. When discarding the device, comply with the rules and regulations that apply in your country. If in doubt, consult your local waste disposal facility.



Musikhaus Thomann · Hans-Thomann-Straße 1 · 96138 Burgebrach · Germany · www.thomann.de