



OCTO MK2 – User Manual

8 universe eDMX to LED pixel controller with network chaining in a compact 4-module DIN-rail form factor. ♥



ENTTEC's OCTO is a robust and reliable installation grade LED controller engineered to take any architectural, commercial or entertainment project to the next level.

With 8 universes of eDMX to pixel protocol conversion and network chaining between devices, the OCTO allows for fast deployment of LED strips and pixel dot systems with compatibility with over 20 protocols.

The OCTO is packed with installer-friendly features such as an identify button to check correct wiring, temperature monitoring, a wide input voltage range (5-60VDC) and intuitive configuration and management through its localhost web interface. All contained within a slim electrically isolated 4 DIN form factor.

Its inbuilt Fx engine allows users to edit and create presets, using the OCTO's web interface that can be configured to run standalone at power up without a DMX source.

Features

- **Two * 4-universe pixel outputs with Data and Clock support.**
- **Support for up to 8 universes of Art-Net, sACN, KiNet and ESP.**
- **Easily extendable network - daisy chain ethernet connection through multiple devices.**
- **DHCP or Static IP address support.**
- **Multiple pixel protocols supported, see: www.enttec.com/support/supported-led-pixel-protocols/.**
- **Surface or TS35 DIN rail mounting option.**
- **Intuitive device configuration and updates through the inbuilt web interface.**
- **Test/Reset button allows installers to quickly check wiring is correct without requiring a network connection.**
- **Simple Fx generator mode to create and execute preset effects on the fly, configurable to play from power up.**
- **Grouping functionality to reduce input channel count.**

Content

Safety.....	3
Electrical safety.....	3
System Planning and Specification	3
Protection from Injury During Installation	4
Installation Safety Guidelines.....	4
Physical Dimensions	4
Wiring Diagrams.....	5
Mounting Options.....	6
Functional features	7
Hardware features	7
LED status indicator	7
Identify / Reset button.....	8
Out of the Box.....	8
Networking.....	8
Web Interface	9
Top Menu	9
Home	10
Settings	10
Direct	11
Group pixels.....	12
DMX start address	12
Standalone	13
Show options – Activating a standalone effect.....	13
Creating a standalone effect	13
Editing a standalone effect	16
Deleting a standalone effect.....	17
Copying a standalone show	17
Importing and exporting a standalone list.....	17
Network stats.....	18
Updating firmware	19
Reset to factory defaults.....	19
Tips and guidelines	20
Servicing, Inspection & Maintenance.....	21
Cleaning.....	21
Package Contents.....	22
Revision update	22
Ordering Information	22

Safety

 **Ensure you are familiarized with all key information within this guide and other relevant ENTTEC documentation before specifying, installing, or operating an ENTTEC device. If you are in any doubt about system safety, or you plan to install ENTTEC device in a configuration that is not covered within this guide, contact ENTTEC or your ENTTEC supplier for assistance.**

ENTTEC's return to base warranty for this product does not cover damage caused by inappropriate use, application, or modification to the product.

Electrical safety

- 
- This product must be installed in accordance with applicable national and local electrical and construction codes by a person familiar with the construction and operation of the product and the hazards involved. Failure to comply with the following installation instructions may result in death or serious injury.
 - Do not exceed the ratings and limitations defined in the product datasheet or this document. Exceeding can cause damage to the device, risk of fire and electrical faults.
 - Ensure that no part of the installation is or can be connected to power until all connections and work is complete.
 - Before applying power to your installation, ensure your installation follows the guidance within this document. Including checking that all power distribution equipment and cables are in perfect condition and rated for the current requirements of all connected devices and factor in overhead and verify that it is appropriately fused and voltage is compatible.
 - Remove power from your installation immediately if accessories power cables or connectors is in any way damaged, defective, shows signs of overheating or are wet.
 - Provide a means of locking out power to your installation for system servicing, cleaning and maintenance. Remove power from this product when it is not in use.
 - Ensure your installation is protected from short circuits and overcurrent. Loose wires around this device whilst in operation, this could result in short circuiting.
 - Do not over stretch cabling to the device's connectors and ensure that cabling does not exert force on the PCB.
 - Do not 'hot swap' or 'hot plug' power to the device or its accessories.
 - Do not connect any of this devices V- (GND) connectors to earth.
 - Do not connect this device to a dimmer pack or mains electricity.

System Planning and Specification

- 
- To contribute to an optimal operating temperature, where possible keep this device out of direct sunlight.
 - Pixel data is unidirectional. Ensure that your OCTO is connected to your pixel dots or tape in a way that ensures data is flowing from the OCTO to the 'Data IN' connection of your pixels.
 - The maximum recommended cable distance between the OCTO's data output and first pixel is 3m (9.84ft). ENTTEC advises against running data cabling close to sources of electromagnetic interference (EMF) i.e., mains power cabling / air conditioning units.
 - This device has an IP20 rating and is not designed to be exposed to moisture or condensing humidity.
 - Ensure this device is operated within the specified ranges within its product datasheet.

Protection from Injury During Installation

- 
 - Installation of this product must be performed by qualified personnel. If ever unsure always consult a professional.
 - Always work with a plan of the installation that respects all system limitations as defined within this guide and product datasheet.
 - Keep the OCTO and its accessories in its protective packaging until final installation.
 - Note the serial number of each OCTO and add it to your layout plan for future reference when servicing.
 - All network cabling should be terminated with an RJ45 connector in accordance with the T-568B standard.
 - Always use suitable personal protective equipment when installing ENTTEC products.
 - Once installation is completed, check that all hardware and components are securely in place and fastened to supporting structures if applicable.

Installation Safety Guidelines

- 
 - The device is convection cooled, ensure it receives sufficient airflow so heat can be dissipated.
 - Do not cover the device with insulating material of any kind.
 - Do not operate the device if the ambient temperature exceeds that stated in the device specifications.
 - Do not cover or enclose the device without a suitable and proven method of dissipating heat.
 - Do not install the device in damp or wet environments.
 - Do not modify the device hardware in any way.
 - Do not use the device if you see any signs of damage.
 - Do not handle the device in an energized state.
 - Do not crush or clamp the device during installation.
 - Do not sign off a system without ensuring all cabling to the device and accessories has been appropriately restrained, secured and is not under tension.

Physical Dimensions

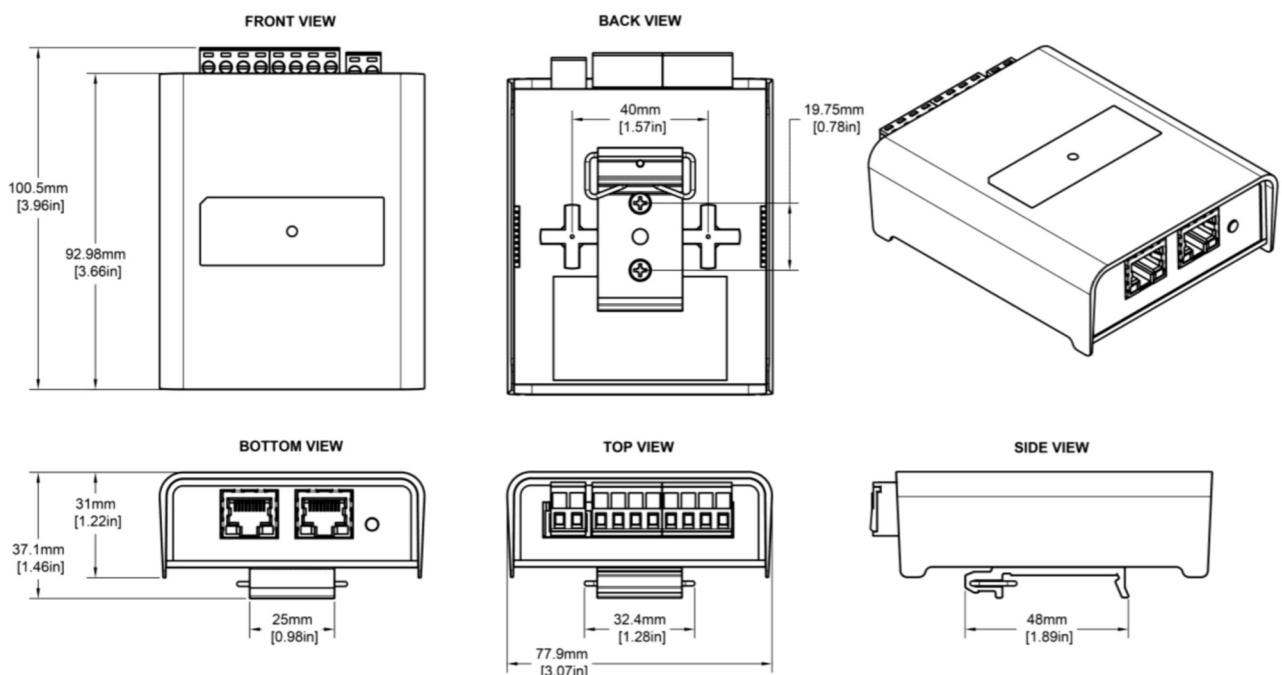

Wiring Diagrams



- Locate the OCTO and PSU as close as possible to the first pixel in your chain to reduce the impact of voltage drop.
- To reduce the likelihood of voltage or Electro Magnetic Interference (EMI) being induced on the control signal lines, where possible, run control cabling away from mains electricity or devices that produce high EMI, (i.e., air conditioning units). ENTTEC recommends a maximum data cable distance of 3 meters. The lower the cable distance, the lower the impact of voltage drop.
- To ensure a reliable connection, ENTTEC recommends the use of cable ferrules for all stranded cables connected to the OCTO's screw terminals.

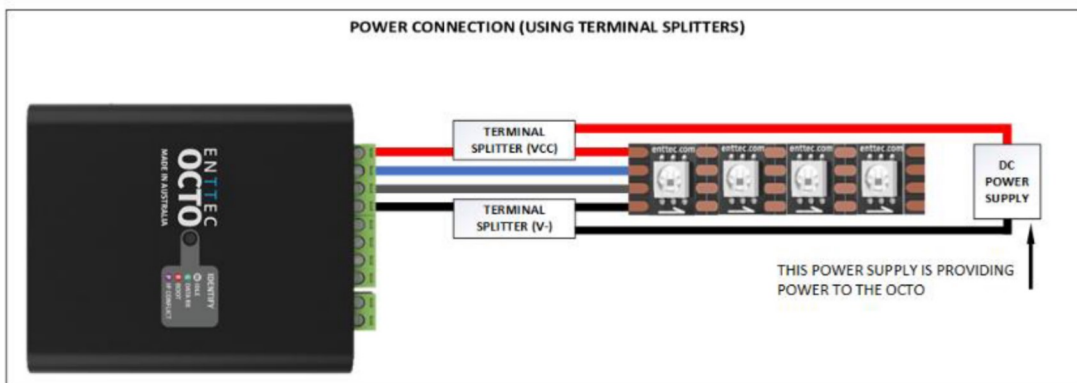
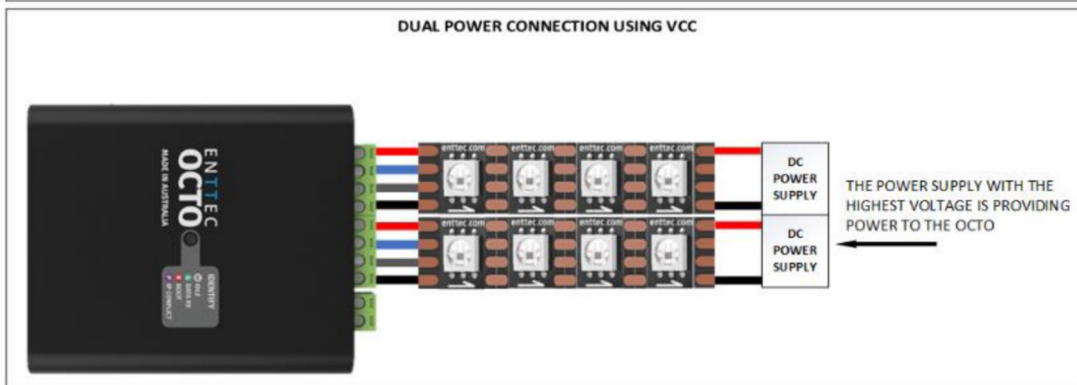
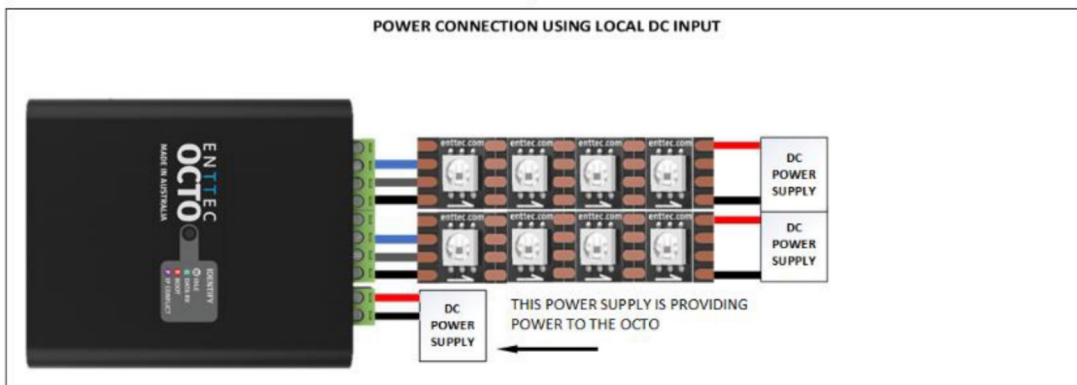
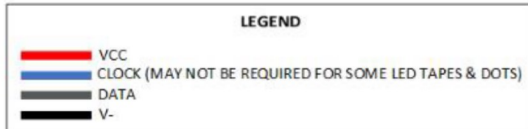

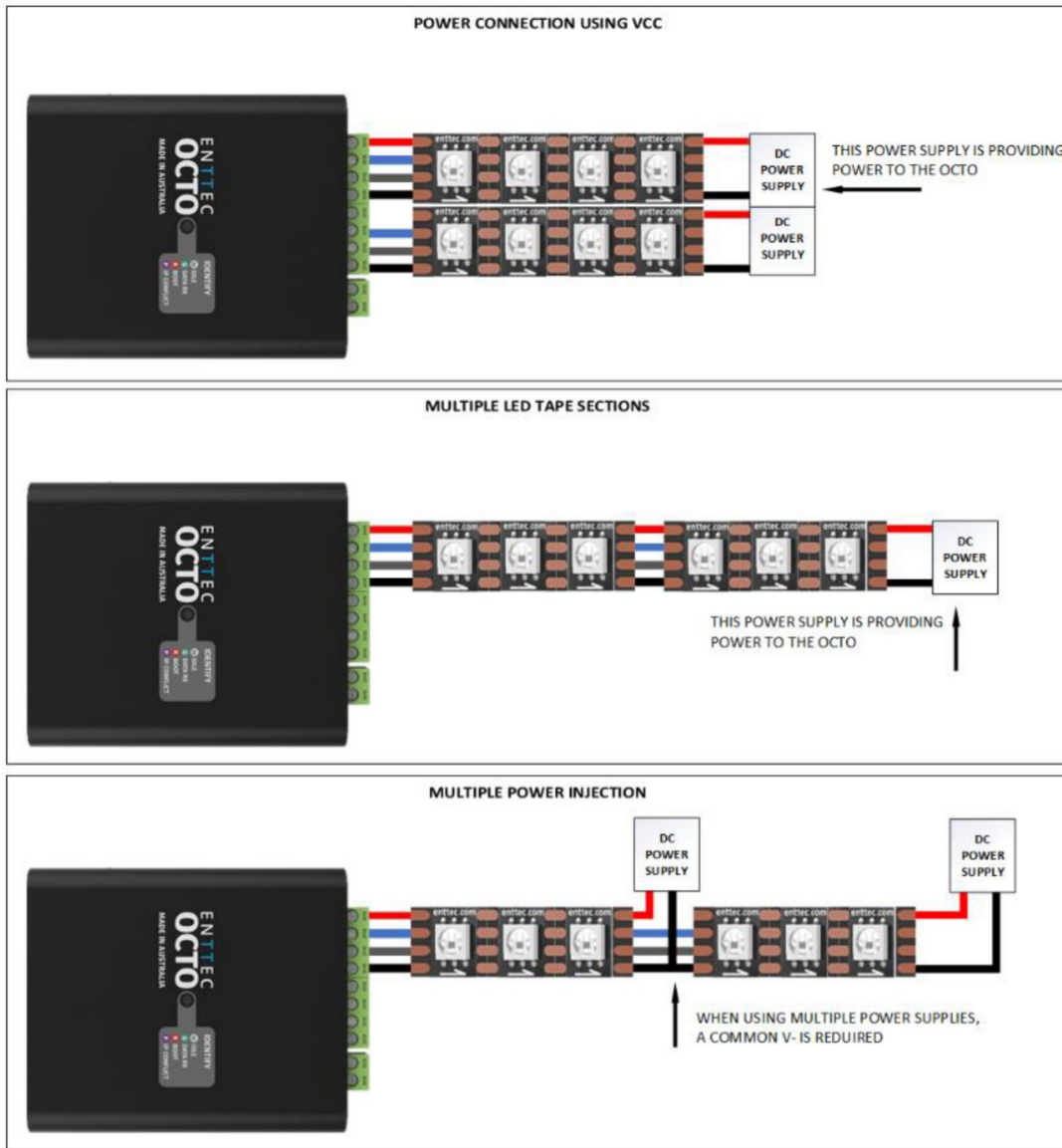

Mounting Options

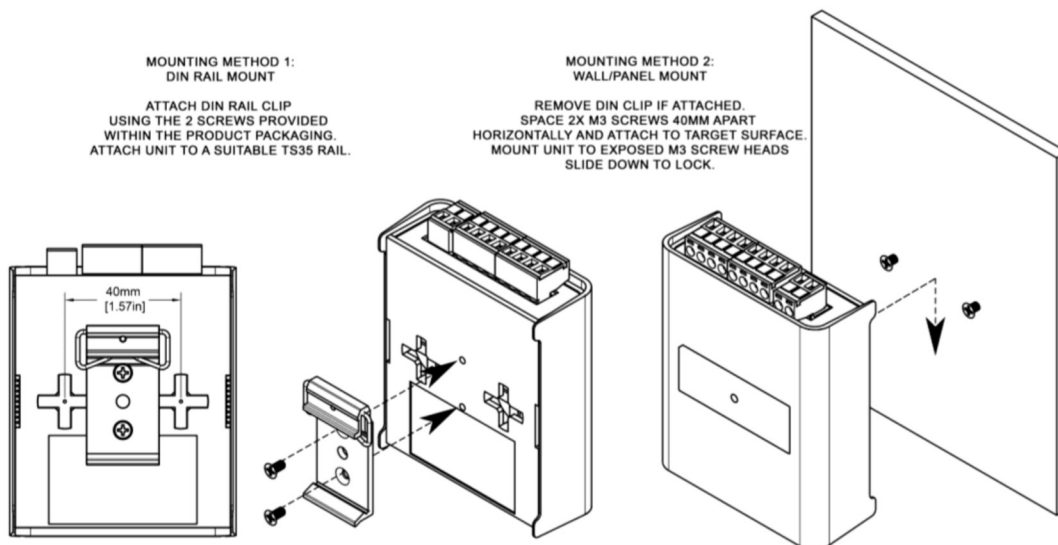

Note: The surface mount tabs have been designed to hold the weight of the OCTO only, excess force by caused by cable strain can cause damage.

Functional features

- The OCTO supports the following input protocols:
 - Art-Net
 - Streaming ACN (sACN)
 - KINET
 - ESP
- The OCTO is compatible with synchronous and asynchronous pixel protocols. For the latest list please refer to: www.enttec.com/support/supported-led-pixel-protocols/.
- RGB, RGBW and White Pixel Order support
- User-friendly interface to create and execute live effects on the fly.
- Save effects to play from power up.
- Maximum output refresh rate is 46 frames per second.

Hardware features

- Electrically insulated ABS plastic housing.
- Forward facing LED status indicator.
- Identify / Reset button.
- Pluggable terminal blocks.
- Link & Activity LED indicator built into each RJ45 port.
- Easily extendable network – daisy chain up to 8 units if the output is in direct mode to ensure sync between pixels. If using in Standalone mode, a maximum of 50 devices can be linked per chain.
- Surface mount or TS35 DIN mount (using provided DIN Clip accessory).
- Flexible wiring configuration.
- 35mm DIN rail accessory (included in packaging).

LED status indicator

The LED status indicator can be used to determine the OCTO's current state. Each state is as follows:

LED Color	OCTO Status
White (static)	Idle
Flashing Green	Direct mode data receiving
Black over White	Standalone mode
Red over Green	Multiple merge sources
Purple	IP conflict
Red	Device in boot / error

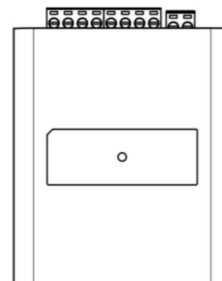

Identify / Reset button

As the name suggests, this button can be used to either:

- Identify pixels connected to a specific OCTO without the need to provide control data.

When the button is pressed in standard operation, all 8 output universes are set to output the highest value (255) for 10 seconds before resuming their previous state. This is a good test to ensure all outputs are connected and working as intended.

Note: The timer will not restart when pressed consecutively.

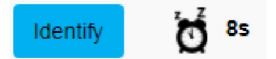

- Reset the OCTO (Refer to the Reset OCTO section of this document).

Out of the Box

The OCTO will be set to a DHCP IP address as default. If the DHCP server is slow to respond, or your network does not have a DHCP server, the OCTO will fall back to the Static IP address which will be 192.168.0.10 as default. By default the OCTO will convert 4 Universe of Art-Net to the WS2812B protocol on each of the OCTO's Phoenix Connector ports. Port 1 will output Art-Net universe's 0 to 3 and Port 2 will output Art-Net universe's 4 to 7.

Networking

The OCTO can either be configured to be a DHCP or Static IP address.

DHCP: On power up and with DHCP enabled, if the OCTO is on a network with a device/router with a DHCP server, the OCTO will request an IP address from the server. If the DHCP server is slow to respond, or your network does not have a DHCP server, the OCTO will fall back to the Static IP address. If a DHCP address is provided, this can be used to communicate with the OCTO.

Static IP: By default (out of the box) the Static IP address will be 192.168.0.10. If the OCTO has DHCP disabled or if the OCTO falls back to the Static IP address after being unable to find a DHCP server, the Static IP address given to the device will become the IP address to communicate with the OCTO. The fall-back address will change from the default once it's modified in the web interface.



Note: When configuring multiple OCTO's on a Static network; to avoid IP conflicts, ENTTEC recommends connecting one device at a time to the network and configuring an IP.

- If using DHCP as your IP addressing method, ENTTEC recommends the use of the sACN protocol, or Art-Net Broadcast. This will ensure that your DIN ETHERGATE continues to receive data if the DHCP server changes it's IP address.
- ENTTEC does not recommend unicasting data to a device with it's IP address set through DHCP server on long term installations.

Web Interface

Configuring the OCTO is done through a web interface which can be brought up on any modern web browser.

- Note: A Chromium based browser (i.e. Google Chrome) is recommended for accessing the OCTO's web interface.
- Note: As the OCTO is hosting a web server on the local network and does not feature an SSL Certificate (used to secure online content), the web browser will display the 'Not secure' warning, this is to be expected.

Identified IP address: If you are aware of the OCTO's IP address (either DHCP or Static), then the address can be typed directly into the web browsers URL field.

Unidentified IP address: If you are not aware of the OCTO's IP address (either DHCP or Static) the following discovery methods can be used on a local network to discover devices:

- An IP scanning software application (i.e. Angry IP Scanner) can be run on the local network to return a list of active devices on a local network.
- Devices can be discovered using Art Poll (i.e. DMX Workshop if set to use ArtNet).
- The device Default IP address will be printed on the physical label on the rear of the product.
- ENTTEC free NMU (Node Management Utility) software for Windows and MacOS (support up to Mac OSX 10.11), which will Discover ENTTEC devices on the Local Area Network, displaying their IP addresses before opting to Configure the device, opening the Web Interface. Note: The OCTO is supported by NMU V1.93 and above.



Note: The eDMX protocols, the controller and the device using to configure the OCTO must be on the same Local Area Network (LAN) and be within the same IP address range as the OCTO. For example, if your OCTO is on Static IP address 192.168.0.10 (Default), then your computer should be set to something such as 192.168.0.20. It is also recommended that all devices Subnet Mask are the same across your network.

Top Menu

The top menu allows all the OCTO web pages to be accessed. Menu option is highlighted blue to indicate which page the user is on.

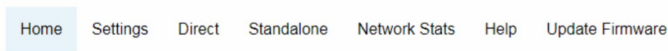

The web interface shows the word Direct or Standalone depending on the mode the device is in, as displayed in the images below:



Home

The Home tab displays the following information:

- DHCP status – (either enabled / disabled).
- IP address.
- Netmask.
- Gateway.
- Mac Address.
- Link Speed.
- Node Name.
- Firmware version on device.
- System uptime.
- Input protocol set on device.
- Output LED protocol set on device.
- Personality.

The screenshot shows the 'Octo - Home' interface with three main sections:

- Network Information:** DHCP: Enabled, IP Address: 10.10.10.95, NetMask: 255.255.255.0, Gateway: 10.10.10.254, Mac Address: 04:91:82:10:1e:13, Link Speed: 100 Mbps.
- System Information:** Node Name: Octo, Firmware Version: ENTTEC Octo Firmware V3.0, System uptime: 7 mins, 43 secs, Input Protocol: Art-Net, Output Protocol: WS2812B, Personality: Direct.
- Identification:** A single 'Identify' button.

Settings

The Settings page allows a user to do the following:

- Change a device name for identification.
- Enable/disable DHCP.
- Specify static network settings.
- Set the output LED Protocol.
- Set the number of mapped pixels.
- Configure how colors are mapped to pixels through the Pixel Order function.
- Reset to factory defaults.
- Reboot the device.

The screenshot shows the 'Octo - Settings' interface with three main sections:

- Network Information:** Node Name: Octo, DHCP: Use DHCP, Static IP Address: 10.8.34.81, Static NetMask: 255.0.0.0, Gateway IP: 10.0.0.254.
- Output Settings:** Led Protocol (Output): APA-102, Pixel Order: Output1: RGB, Output2: RGB, Mapped Pixels: Output1: 680 Max, Output2: 680 Max.
- Save & Update:** Save: Save Settings, Factory Default: Reset to Defaults, Device Reboot: Reboot.

Direct

Direct mode can be activated by clicking on the 'Use Direct mode' button on the Direct page as shown in the image below.

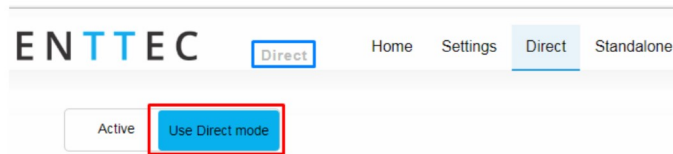

When activated, the word Direct will be displayed next to the ENTTEC logo.

DMX protocols

KiNET

Supported commands:

- Discover device.
- Discover ports on device.
- Change device name.
- Change device IP.
- Portout commands.
- DMX out commands.
- KGet Command:
 - KGet Subnet Mask.
 - KGet Gateway.
 - KGet port universe (port 1 and 2).
 - KSet commands.
 - KSet Subnet Mask.
 - KSet Gateway.
 - KSet port universe (port 1 and 2).
 - KSet device to boot.

Art-Net

Supports Art-NET 1/2/3/4. Each output port can be assigned a start universe in the range 0 to 32764.

sACN

Outputs can be assigned a start universe in the range 1-63996 (when universe/output = 4).

Note: The OCTO supports a maximum of 1 multicast universe with sACN sync. (i.e., all universes set to the same value)

ESP

Outputs can be assigned a start universe in the range 0-252 (when universe/output = 4). More details of the ESP protocol can be found at www.enttec.com

Universes/Outputs

The OCTO converts up to four universes of DMX over Ethernet to pixel data per output.

Both outputs can be specified to use the same universes, e.g., both outputs use universe 1,2,3 and 4.

Each output can also be specified to use its own individual group of universes, e.g., output 1 uses universes 100,101,102 and 103 however output 2 uses 1,2,3 and 4.

Only the first universe can be specified; the remaining universes, second, third and fourth are automatically assigned subsequent universes to the first one.

Example: If the first universe is assigned 9, the second, third and fourth universes will be automatically assigned 10, 11 and 12 as shown in the image below.

Pixel Mapping Options ⓘ	
Output1	
Universes/Outputs:	4 ▾
First Universe:	9
Second Universe:	10
Third Universe:	11
Fourth Universe:	12

Group pixels

This setting allows multiple pixels to be controlled as one ‘virtual pixel’. This reduces the overall amount of input channels required to control pixel strip or dots.

Example: When ‘group pixel’ is set to 10 on an OCTO connected to a length of RGB pixel strip, by patching a single RGB pixel within your control software and sending the values to the OCTO, the first 10 LED’s would respond to it.

Note: The maximum number of physical LED pixels that can be connected to each OCTO is 680 (RGB) or 512 (RGBW). When grouping pixels, the number of control channels required is reduced, this function does not increase the number of physical LED’s each OCTO can control.

DMX start address

Selects DMX channel number, which controls the first pixel. When the universes/output is more than one, the DMX start address only applies to the first universe.

However, where it applies, a start address offset may result in the split of a pixel. e.g., **R** channel in first universe and **GB** channels in the seconds universe for a **RGB** LED.

For ease of pixel mapping, ENTTEC recommend offsetting the DMX start address to a number divisible by the number of channels per pixel. i.e.:

- Increments of 3 for RGB (i.e., 1,4,7, 10)
- Increments of 4 for RGBW (i.e., 1,5,9,13)
- Increments of 6 for RGB-16 bit (i.e., 1,7,13,19)
- Increments of 8 for RGBW-16 bits (i.e., 1,9,17,25)

Standalone

Standalone is to be used to create a looping effect that can be played back from the point the OCTO is powered on. – This can also be of use to test the OCTO’s output without the need to send eDMX data.

Standalone can be activated by clicking on the ‘Use Standalone mode’ button as shown below:

When activated, the word Standalone will be displayed next to the ENTTEC logo.

Note: When operating in Standalone mode:

- 16Bit protocols are not supported
- RGBW tapes are supported but white cannot be controlled.

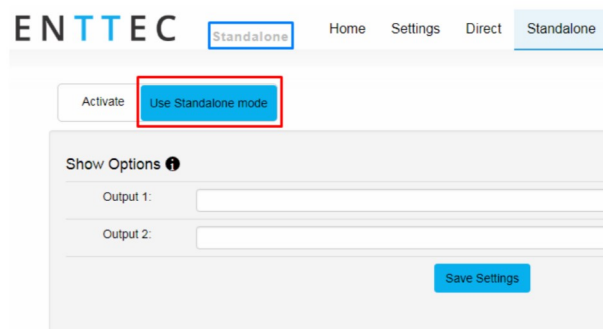

Show options – Activating a standalone effect

The OCTO allows the control of standalone effects on both outputs. This is controlled by the Show Options section. Both can be set to output no standalone show:

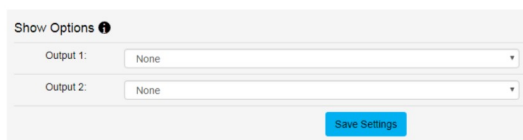

The outputs can play the same standalone show concurrently:

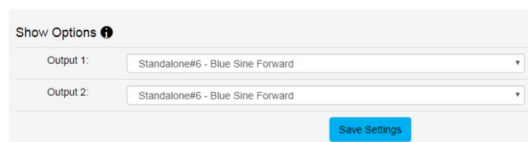

Or each can be set to output a different show:



Creating a standalone effect

A standalone show can only be created when Standalone mode is activated. Follow the steps below to create a standalone (effect):

1. Select the next available standalone slot and click on the ‘create’ button.

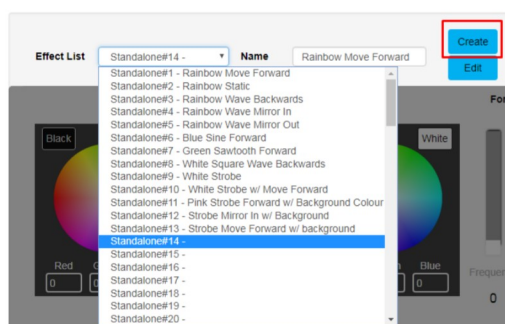

2. Select an output to preview the standalone show on by using the check boxes.

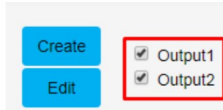

3. If the effect previewed is to be preserved, Type in a name and click on 'Save Effect' button.

Preview standalone effects

OCTO allows the preview of the standalone. Select the output to preview the standalone as shown in the previous image.

If two different colour orders e.g.: RGB on output 1 and WWA in output 2 are assigned you can only preview the effect on one output at a time. If you attempt to preview both outputs the following message is displayed.

Standalone effects name

Up to 65 characters can be used for a standalone name. All characters are supported except comma (,). The OCTO does not allow a standalone to be saved with an existing name on the list.

Standalone layers explained

When creating a standalone the light output should be visualized as two layers:

- Background (controls shown in red)
- Foreground (controls shown in blue)

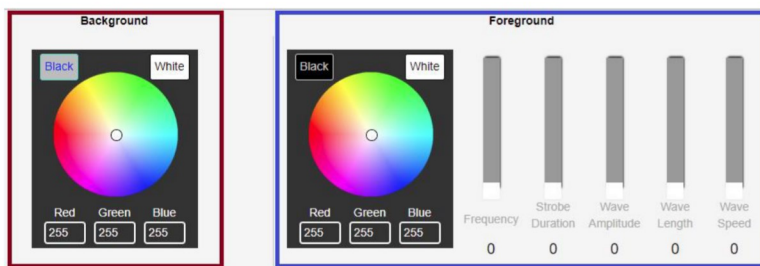

The OCTO has colour wheel support for RGB pixel strip.

Background

By only enabling the background layer the pixel tape/dots will respond like a standard RGB tape.

The controllers affect the entire length up to the maximum possible pixels (e.g., 680 3-channel pixels).

Foreground

This layer creates effects that overlay on the background colour. The foreground can be:

- Set to a constant color.
- Dimmed.
- Made to strobe.
- Set to create patterns.

Master intensity

Master intensity controls the overall brightness of the output (both for foreground and background). Where:

- 0 – no LEDs ON.
- 255 – LEDs on are at full brightness.

Foreground strobe frequency

Controls the time between LED(s) on and off time:

- 0 – LEDs switch on and off at slowest speed.
- 255 – LEDs switch on and off at fastest speed.

Foreground strobe duration

Controls the time that the LEDs are on:

DMX fader value	On time
0	Always on
1	Smallest duration
255	Longest duration

Wave function

The foreground layer can be controlled to form patterns of the following wave functions:

- Sine wave.
- Log wave.
- Square wave.
- Sawtooth wave.
- Rainbow Sine Wave.
- Rainbow Log Wave.
- Rainbow Square Wave.
- Rainbow Sawtooth.

Wave direction

The wave pattern can be set to travel. Wave direction setting determines which way the pattern will travel. The wave can be set to move:

- Forward.
- Backward.
- Mirror out – pattern travelling out of center.
- Mirror in – pattern travelling into center.

Wave amplitude

This setting determines the brightness of each pixel in a period of the wave.

DMX fader value	Brightness of pixels per wave period
0	Vary between 50% and full
255	Vary between off and full on.

Wavelength

This setting determines the number of pixels in one period of the wave.

DMX fader value	Wavelength
0-1	2 pixels
2-255	Fader Value

Wave speed

This setting controls the speed at which the wave pattern travels across tape.

DMX fader value	Speed
0	Minimum speed
255	Maximum speed

Offset

Offset allows the pattern on a port to be delayed.

Editing a standalone effect

The OCTO allows the editing of any saved standalone effect.

Follow the steps below to edit a standalone:

1. Select the standalone to be edited and click on the Edit button.

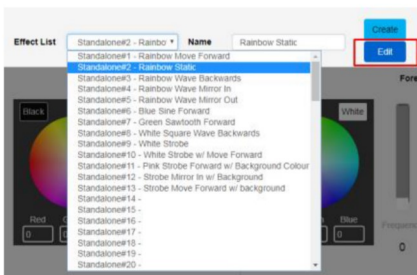

2. Select an output to preview the standalone on by using the check boxes.



3. Edit the standalone.
4. If the standalone previewed is to be preserved, click on Save Effect button.

Deleting a standalone effect

Select the standalone to be deleted and press on the Delete button.

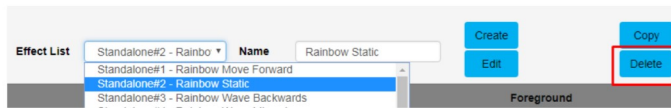

The standalone selected for each output will continue to play unless it is deleted; in this case, the standalone directly above will be enabled at the output, which had the deleted show. If there is no standalone above, no standalone will be output.

If a slot without a standalone is deleted the following message is displayed:

10.10.3.26 says
Please select a preset!



Copying a standalone show

The OCTO allows the copying of any saved standalone effect.

Follow the steps below to copy a standalone effect:

1. Select the effect to be copied and click on Copy button.

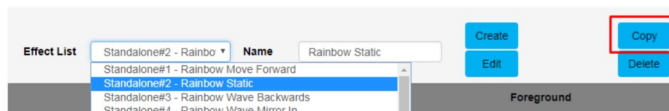

2. Provide a new name for the copied standalone effect.

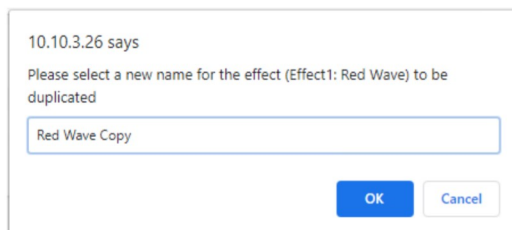

Note: The OCTO does not permit shows to be saved with the same name.

Importing and exporting a standalone list

The OCTO allows the import and export of all the standalone shows on the device.

Note: The export file will include a list of all the standalone shows

Please click on Export Effect button to export the standalone shows:



Please click on Import Effect button to import the standalone shows:

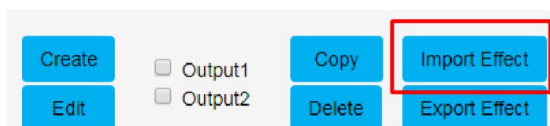

Network stats

The Network page shows statistics for the DMX protocol enabled.

Art-Net

The information provided is:

- Poll packets received.
- Data packets received.
- Sync packets received.
- Last IP poll packets were received from.
- Last port data received from.

Network Protocol: Art-Net ⓘ	
Poll Packets Received:	0
Data Packets Received:	0
Sync Packets Received:	0
Last IP:	0.0.0.0
Last Port:	0

[Refresh](#)

ESP

The information provided is:

- Poll packets received.
- Data packets received.
- Last IP poll packets were received from.
- Last port data received from.

Network Protocol: ESP ⓘ	
Poll Packets Received:	150
Data Packets Received:	708
Last IP:	10.10.3.3
Last Port:	6454

[Refresh](#)

sACN

The information provided is:

- Data and sync packets received.
- Last IP packets were received from.
- Last port data received from.

Network Protocol: sACN ⓘ	
Data Packets Received:	106
Sync Packets Received:	86
Last IP:	10.10.0.39
Last Port:	5568

[Refresh](#)

KiNET

The information provided is:

- Total packets received.
- Discover supply packets received.
- Discover ports packets received.
- DMXOUT packets.
- KGet packets.
- KSet packets.
- PORTOUT packets.
- Set device name packet received.
- Set device IP packet received.
- Set universe packets received.
- Last IP received from.
- Last port data received from.

Network Protocol: KiNET ⓘ	
Total packets received:	2701
Discover Supply packets received:	2
Discover Ports packets received:	2
DMXOUT packets received:	0
KTYPE_GET packets received:	0
KTYPE_SET packets received:	0
PORTOUT packets received:	2685
PORTOUT Sync packets received:	10
Set ID packets received:	1
Set IP Address packets received:	1
Set Universe packets received:	0
Last IP:	10.10.0.127
Last Port:	65379

[Refresh](#)

Updating firmware

It is strongly recommended that the OCTO is updated with the latest firmware, available on the ENTTEC website. This firmware can be loaded to the driver through its web interface by carrying out the following steps:

1. Browse and select the correct firmware version on your PC.



2. Press the Update Firmware button.

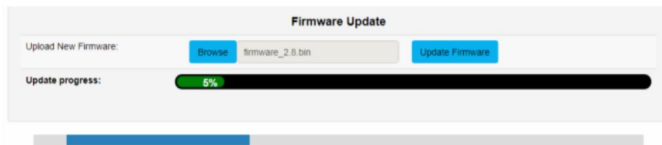

Once the firmware update is complete, the device will reboot while the web interface displays the message shown in the image below:



Reset to factory defaults

Factory resetting the OCTO results in the following:

- Resets the device name.
- Enables DHCP.
- Static IP Address reset (IP address = 192.168.0.10).
- Resets the gateway IP.
- Netmask is set to 255.0.0.0
- Restores standalone shows to factory default.
- Direct mode is activated.
- Input protocol is set to Art-Net.
- LED protocol is set as WS2812B.
- Pixel color is set to RGB.
- Both ports are set to output 4 universes. The start universe for output 1 & output 2 is set as 0.
- Mapped pixels value is set to 680 pixels.
- DMX start address is set to 0.
- APA-102 global intensity set to maximum.

Using web interface

The reset to defaults command can be found under the Settings tab of the OCTO.



Once the command is pressed, a pop-up would appear as shown in the image below:

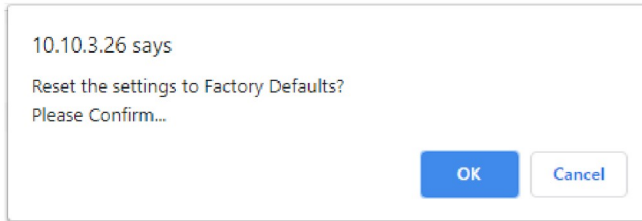

Using the reset button

The reset button restores the network configuration of the OCTO to factory defaults:

- To reset to factory defaults, the following procedure must be performed:
- Power off the unit
- Press and hold the Reset button.
- While holding the Reset button, power up the unit, and keep holding the button for 3 seconds.
- Release the Reset button once the status led starts blinking red.

Tips and guidelines

I'm unable to connect to the OCTO web interface:

Ensure that the OCTO and your computer are on the same subnet

To troubleshoot:

1. Connect the OCTO directly to your computer using a Cat5 cable and power it on.
2. Give your computer a Static IP address (e.g.: 192.168.0.20)
3. Change computer Netmask to (255.0.0.0)
4. Open NMU and select the network adaptor connected to your OCTO.
5. If you have multiple networks (WiFi etc.), please try to disable all other networks except the one OCTO is connected to.
6. Once NMU finds the OCTO, you will be able to open the device webpage and configure it.
7. Factory Reset the device using the button if following the steps above and navigate to the OCTO's default IP if this did not resolve the issue.



Is it possible to run pixel tapes and dots using different protocols and voltages at the same time?

No, only one LED protocol can be selected to drive the output at a given time.

What is the minimum DC voltage for powering the OCTO?

The minimum DC voltage the OCTO requires to run is 4v.

Servicing, Inspection & Maintenance

-  ■ **The device has no user serviceable parts. If your installation has become damaged, parts should be replaced.**
-  ■ **Power down the device and ensure a method is in place to stop the system from becoming energized during servicing, inspection & maintenance.**

Key areas to examine during inspection:

- Ensure all connectors are mated securely and show no sign of damage or corrosion.
- Ensure all cabling has not obtained physical damage or been crushed.
- Check for dust or dirt build up on the device and schedule cleaning if necessary.
- Dirt or dust buildup can limit the ability for a device to dissipate heat and can lead to damage.



The replacement device should be installed in accordance with all steps within the installation guide.

To order replacement devices or accessories contact your reseller or message ENTTEC directly.

Cleaning

Dust and dirt build up can limit the ability for the device to dissipate heat resulting in damage. It's important that the device is cleaned in a schedule fit for the environment it is installed within to ensure maximum product longevity.

Cleaning schedules will vary greatly depending on the operating environment. Generally, the more extreme the environment, the shorter the interval between cleanings.

-  ■ **Before cleaning, power down your system and ensure a method is in place to stop the system from becoming energized until cleaning is complete.**
-  ■ **Do not use abrasive, corrosive, or solvent-based cleaning products on a device.**
-  ■ **Do not spray device or accessories. The device is an IP20 product.**

To clean an ENTTEC device, use low-pressure compressed air to remove dust, dirt and loose particles. If deemed necessary, wipe the device with a damp microfiber cloth.

A selection of environmental factors that may increase the need for frequent cleaning include:

- Use of stage fog, smoke or atmospheric devices.
- High airflow rates (i.e., in close proximity to air conditioning vents).
- High pollution levels or cigarette smoke.
- Airborne dust (from building work, the natural environment or pyrotechnic effects).

If any of these factors are present, inspect all elements of the system soon after installation to see whether cleaning is necessary, then check again at frequent intervals. This procedure will allow you to determine a reliable cleaning schedule for your installation.

Package Contents

- OCTO
- 2* WAGO connectors
- 1 * Din mounting clip + screws

Revision update

OCTO MK2 released in Jan 2022. Do not load MK1 FW.

Last OCTO MK1 SN: 2318130. *Kindly specify your device's SN for support.*

Ordering Information

For further support and to browse ENTTEC's range of products visit the [ENTTEC website](#).

Item	SKU
OCTO MK2	71521

enttec.com

MELBOURNE AUS / LONDON UK / RALEIGH-DURHAM USA

Due to constant innovation, information within this document is subject to change.