

Pearl.
Snare Drums



4

Masters Custom Gold

- 4 ply, 100% Maple Shell
- 13 Available colors
- 24k Gold plated hardware



MMX-5114G



MMX-5114DG



MMX-5314DG

5

Masters Custom

- 4 ply, 100% Maple Shell
- 13 Available colors
- 2 Models with Multi-Trace Strainer



MMX-5114C



MMX-5114DC



MMX-5314D

6

Mahogany Classic Limited Edition

- 4 ply, 100% African
- 2 Exotic Burlwood Models
- 2 Models in kit matching Red Mahogany



MH-5314DG



MH-5314D



MHX-5514



MHX-5514D

7

Masters Series Symphonic Custom

- 6 ply, 100% Maple shell
- New Multi-Timbre throw-off
- 3 individually controllable snares
- Vintage style tube lugs
- Beautiful Antique Sunburst Lacquer finish



SY-6514



SY-6514D

8

Signature Series Models**Dennis Chambers & John Robinson**

- DC Model, 4 ply, 100% Maple shell available in 24k gold or chrome
- Multi-Trace 3 position strainer
- JR Model, 6 ply, 100% Maple shell extremely versatile, unique 4" depth



DC-5314D



DC-5314DG



JR-5314P

9

Signature Models**Omar Hakim & Chad Smith**

- OH Model, 6 ply African 5"x13" in both 24k gold and chrome
- CS Model, black nickel steel shell, great rock drum



OH-4213G



OH-4213



CS-4214

10

SensiTone Classic

- Available with Bronze or Brass shell
- Projection ring molded into shell
- Sensitive response, great tone
- Vintage single flange hoops, die-cast claws
- Tube lugs
- Rimshooter stick guards



BR-6514CL



B-6514CL



S-5513

SensiTone Power Piccolo

- Available with Steel or Brass shell
- Projection ring molded into shell
- Sensitive response, great tone
- Unique 5"x13" size
- Piccolo attack, yet full-bodied sound
- Super Hoop II's, bridge style lugs



BR-6514DCL



B-6514DCL



B-5513

11

SensiTone Custom Alloy

- 3 Shell choices, Bronze, Brass, Steel
- Projection ring molded into shell
- Sensitive response, great tone
- SuperHoop II's, bridge style lugs



BR-5514

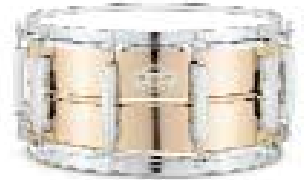

BR-5514D

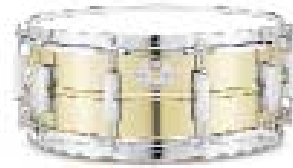

B-5514



B-5514D



S-5514

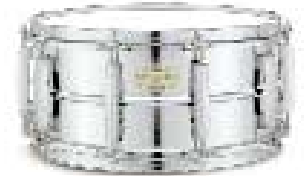

S-5514D

12

Free Floating System (pg. 12-13)

- 6 ply Maple, Brass and Steel Shells
- No hardware touches the shell
- Die-Cast Hoops on Brass and Maple
- Aircraft quality Aluminum Edge ring
- Extended snares
- Shells are interchangeable

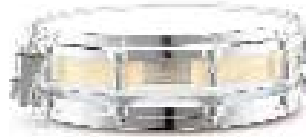

M-9114P



M-9114



M-9114D

13



SL-8114P

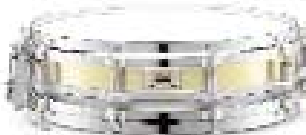

B-9114P

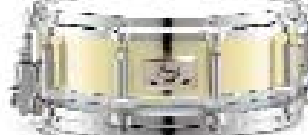

B-9114

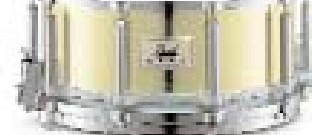

B-9114D

14

Soprano, Effects, Sopraninos

- Brass, Steel and Maple Sopranos 3"x13" size with excellent attack
- 8 ply Maple Effects snare, 7"x12" size with unequalled volume and projection
- 6 ply Maple Sopraninos, 4"x10" and 4"x12" sizes, great secondary snares

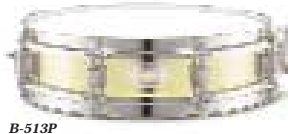

B-513P

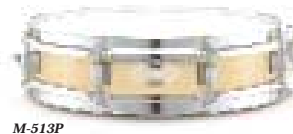

M-513P

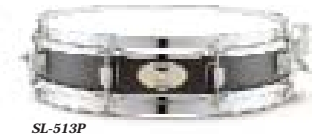

SL-513P



M-712SE



M-412SN



M-410SN

15

Genuine Pearl Snare Parts

- Excellent quality and price
- Update any snare with Pearl Parts
- Exact replacement on strainers, lugs, hoops, snares plus more.



16

Snare Stands

- Premium Pearl Construction, features and durability
- Various drumset and concert height models



S-985W



S-885W



S-850



S-800WL



S-800W

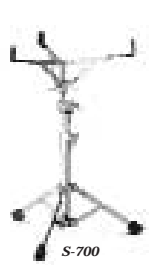

S-700

Masters Custom Gold Snare Drums

Four-ply, 100% aged Maple shell with proportional reinforcement rings at both top and bottom, and the stunning beauty of true 24k gold plated hardware... this is Masters Custom Gold. All Masters Custom Gold Series Snare Drums feature our SR-015 "Gladstone Style" Vertical Pull throw-off, 24k gold plated wire snares with vintage style cord pulls, and 13 beautiful lacquer finishes from which to choose. Masters Custom Gold is a snare drum that looks, feels and sounds like nothing you've played before.



MMX-5114G in #102 Natural



MMX-5114DG in #102 Natural



MMX-5314DG in #102 Natural



The warm, resonant tone produced by our Masters Custom Gold Series Snare Drums is rich with stunning attack and a full bodied projection only available from our 100% Maple 4-ply shells.

Three available models offer you a choice of either our classic bridge style lugs or our Masters Series low-mass vintage double lugs. Both the 5 1/2" MMX-5114G and the 6 1/2" MMX-5114DG feature bridge style lugs and 24k gold plated steel hoops. The MMX-5314DG provides 24k gold plated die-cast hoops and our Masters Series double lugs.

Masters Custom Gold Snare Drums feature our smooth, fast, precisely adjustable SR-015 "Gladstone Style" Vertical Pull throw-off system.

13 Available Colors

9 high gloss and 4 satin stained "Burnish" finishes.



#100 Wine Red

#102 Natural

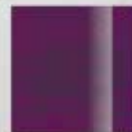

#127 Purple Mist



#103 Piano Black



#109 Arctic White



#110 Sequoia Red



#126 Emerald Green



#114 Liquid Amber



#122 Black Mist



#180 Orange Burnish



#181 Amber Burnish



#182 Walnut Burnish



#183 Wine Burnish

	MMX-5114G	MMX-5114DG	MMX-5314DG
Size	5 1/2" X 14"	6 1/2" X 14"	6 1/2" X 14"
Shell Material	5mm/4 ply maple	5mm/4 ply maple	5mm/4 ply maple
Hoops	2.3mm super	2.3mm super	die cast
Lugs	CL-55	CL-65	Masters single
Strainer	SR-015G	SR-015G	SR-015G
Snares	S-022NG	S-022NG	S-030G
Tension #	10	10	10
Plating	gold	gold	gold

Masters Custom Snare Drums

Our renowned Masters Custom Snare Drums offer you a choice of two outstanding snare throw-off systems, thirteen color choices, die-cast or 2.3mm steel Superhoops, and either bridge type or our low-mass classic Masters double lugs. Masters Custom Snare Drums feature a 4 ply, 5mm air cured and aged 100% Maple shell, formed by Pearl's patented Heat Compression Shell Molding Process. This outstanding shell produces a warm resonant tone with sharp attack, excellent projection and an evenly distributed midrange with exceptional low end depth. If you are looking for the ultimate wood shell snare drum, your search is over. Masters Custom is without doubt, one of the finest snare drums on the market today.



MMX-5114C in #122 Black Mist

MMX-5114DC in #126 Emerald Mist

MMX-5314D in #100 Wine Red

Multi-Trace Strainer

Our new SR-020 Multi-Trace Strainer system provides the standard full off and full on snare settings, plus two effects settings in between. By simply clicking the strainer to the next setting, you now have a much wider range of voicings and snare effects, without having to buy additional drums. The Multi-Trace Strainer System is standard on models MMX-5114C and MMX-5114DC only.



13 Available Colors

Our Masters Custom Maple Shell Snare Drums are available in thirteen beautiful exterior finishes as shown at left on page 4.

	MMX-5114C	MMX-5114DC	MMX-5314D
Size	5 1/2" X 14"	6 1/2" X 14"	6 1/2" X 14"
Shell Material	5mm/4 ply maple	5mm/4 ply maple	5mm/4 ply maple
Hoops	2.3mm super	2.3mm super	diecast
Lugs	CL-55	CL-65	Masters single
Strainer	SR-020	SR-020	SR-015
Snare	S-022N	S-022N	S-030N
Tension #	10	10	10
Plating	chrome	chrome	chrome

Mahogany Classic Limited Edition

Pearl's Mahogany Classic Limited Edition Snare Drum represents a unique blend of warm vintage tone, modern aesthetics and cutting edge snare drum design principles. Our unique 100% premium African Mahogany 4 ply shell, with proportional reinforcement rings at both top and bottom, produces a very warm and resonant full bodied classic tone. Few snare drums ever produced can match the beauty offered by our naturally finished exotic "Burl Mahogany" models, in your choice of either 24k gold or chrome plated hardware. We also offer two models featuring a stunning Red Mahogany finish that perfectly compliments the look of our Masters Series Mahogany Classic drums. After hearing the Mahogany Classic Limited Edition Snare Drum, we think you'll agree, that this is one drum that definitely sounds as good as it looks.



MH-5314DG



MH-5314D



MHX-5514



MHX-5514D



Both of our Burl Mahogany Classic Limited Edition Snare Drums feature Mahogany reinforcement rings, die-cast counter hoops with integrated snare guards, our new SR-015 "Gladstone Style" vertical pull throw-off, CL-100 split low-mass double lugs and our 24 strand S-030N snares. The Red Mahogany models offer Maple reinforcement rings, 2.3mm steel SuperHoop II's, our SR-017 Throw-off, minimum contact bridge style lugs and our S-022N snares.

	MH-5314DG	MH-5314D	MHX-5514	MHX-5514D
Size	6 1/2" X 14"	6 1/2" X 14"	5 1/2" X 14"	6 1/2" X 14"
Shell Material	5mm/4 ply mahogany	5mm/4 ply mahogany	5mm/4 ply mahogany	5mm/4 ply mahogany
Hoops	Die cast	Die cast	2.3mm Super	2.3mm Super
Lugs	CL-100G	CL-100	CL-55	CL-65
Strainer	SR-015G	SR-015	SR-017	SR-017
Snares	S-030NG	S-030N	S-022N	S-022N
Tension #	10	10	10	10
Plating	gold	chrome	chrome	chrome

Masters Series Symphonic Custom

Our new Masters Series Symphonic Custom is the ultimate expression of excellence in concert quality snare drum design. Developed exclusively for the concert hall, this outstanding drum features a 6 ply, 7.5mm thick, 100% aged Maple shell, formed by Pearl's patented Heat Compression Shell Molding System, finished in beautiful high gloss Antique Sunburst. Classic tube lugs with separate tension clips and single flange hoops give this drum an unmistakable vintage look. But in sharp contrast to its classic visual is the state of the art precision and versatility of the finest snare system on the market today. Our new Multi-Timbre Snare Strainer System features three separate adjustable throw-offs in one unit, controlling light cable, heavy cable and wire snares, in any combination, providing unbelievable control and endless sound options. No other snare drum on the market offers such a perfect combination of classic styling, supreme quality and craftsmanship, unsurpassed tonality, and the unprecedented control and versatility offered by our new Multi-Timbre snare system.



Our new Symphonic Custom is available in both 5.5"x14" and 6.5"x14" sizes. Both offer 10 tube style tension lugs, our 2.3mm steel single flanged hoops with RimShooter stick guards, Remo® Renaissance batter and snare side batter heads, and the revolutionary Multi-Timbre Snare Strainer.

	SY-6514	SY-6514D
Size	5½" X 14"	6½" X 14"
Shell Material	7.5mm/6 ply aged maple	7.5mm/6 ply aged maple
Hoops	single flange	single flange
Lugs	tube	tube
Strainer	Multi-Timbre	Multi-Timbre
Snares	3 seperate	3 seperate
Tension #	10	10
Plating	chrome	chrome



Signature Series Snare Drums

Our Dennis Chambers Signature Series Snare Drums reflect the outstanding sound and tonal dynamics that are characteristic of every Dennis Chambers performance. Designed totally by Dennis and Pearl's development team, this drum offers two of our Multi-Trace Throw-Off Systems, the warm resonate tone of a 100% 4 ply Maple shell, with reinforcement rings at both top and bottom, and the stunning pearlescent beauty of our highly polished Opal White exterior finish.

To read "JR" Robinson's studio credits is like reading a who's who of the top performers in the music business. The incredible recording sound obtained from his Masters Series drums is based around this 6 ply 100% hand selected Maple 4" x 14" Signature Series Snare Drum. It produces a sound that is warm, crisp and offers great projection and a tuning latitude few drums can match. Its versatility allows you to create sounds ranging from a piccolo to a deep snare sound, and everything in between. Like all of our Signature Series Snares, John's offers a deeper snare bed to increase sensitivity and edge response.



Our Multi-Trace Throw-Off System offers 4 pre-set positions providing a larger array of available snare sounds from one drum. Two Multi-Trace Throw-offs, one on each side, as found above on our Dennis Chambers Signature Series Snare Drum, allow you to fine tune your snare sound like never before. Our S-030N, 24 strand Snares provide great sensitivity, without choking, even under the most extreme playing conditions.

Dennis Chambers

Dennis Chambers is considered by many to be one of the most talented professional drummers to ever play. His Signature Snare Drum offers a warm, full bodied tone with excellent volume and clarity and incorporates cutting edge design features that distinguish this drum from all others you have ever seen.

	DC-5314D	DC-5314DG
Size	6 1/2" X 14"	6 1/2" X 14"
Shell Material	5mm/4 ply 100% Maple	5mm/4 ply 100% Maple
Hoops	Die cast	Die cast
Lugs	Masters single	Masters single
Strainer	two SR-020	two SR-020
Snares	S-030N	S-030N
Tension #	10	10
Plating	chrome	gold

	JR-5314P
Size	4" X 14"
Shell Material	7.5mm/6 ply Maple
Hoops	Die-Cast
Lugs	CL-05
Strainer	SR-018
Snares	S-022N
Tension #	10
Plating	chrome

John "JR" Robinson

John "JR" Robinson's studio career seems almost beyond belief. His signature sound can be heard on projects with Michael Jackson, Barbara Streisand, Quincy Jones, Herbie Hancock, Rod Stewart, Michael Bolton and many, many others. John's Signature Series Snare Drum offers a rich, warm full bodied tone and its size creates a versatility unmatched among professional snare drums.

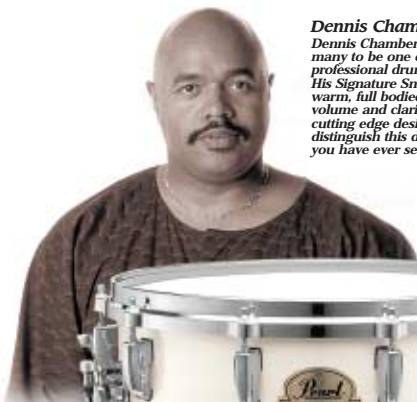

DC-5314D



DC-5314DG



JR-5314P

Signature Series Snare Drums

Anyone that has heard Omar Hakim perform will remember the power and dynamic tonality of his snare sound. Our Omar Hakim Signature Series Snare Drums offer a unique voice that many call the "Power Piccolo" sound. These exclusive 5" x 13" snare drums offer a rare naturally finished six ply 100% African Mahogany shell, 2.3mm steel counter hoops, our SR-015 "Gladstone Style" Vertical Pull Throw-Off, and your choice of either 24k gold or chrome plated hardware. The characteristic warmth and slightly darker and drier sound of the 100% natural Mahogany shell, combined with its unique 5" x 13" size, produces the perfect blend of sonic power, projection, cutting attack and tonal color.

Few drummers today are both as outrageous and as dedicated to the art of drumming as Chad Smith. His signature sound is consistently one of the best overall rock drum sounds today. Chad's Signature Series Snare Drum reflects his outrageousness, his dedication to perfection, and offers an awesome rock snare sound. This drum is one of the most sensitive snare drums we offer. Its sound is very bright and articulate with great body, a very smooth frequency response and a wide tuning range. Our Chad Smith Signature Snare Drum looks as good as it sounds offering an exclusive 5" x 14" black nickel plated steel shell, our CL-55 "Bridge Style" minimum contact lugs, 2.3mm SuperHoop II's and our "Gladstone Style" Vertical Pull Throw-Off.



Both our Omar Hakim and Chad Smith Signature Snare Drums feature our CL-55 "Bridge Type" low mass lugs, 2.3mm steel Superhoop II's and our SR-015 Vertical Pull Strainer that pulls the snares against the head, instead of across it, to create a more sensitive and responsive sound.

Omar Hakim

Omar Hakim has built a signature sound that is reflected in his live and studio performances with artists that include Sting, Madonna, Dire Straits, Weather Report and countless others. His Signature Snare Drum captures both the dynamics of his playing and the depth of his sound.

	OH-4213G	OH-4213
Size	5" X 13"	5" X 13"
Shell Material	7.5mm/6 ply Mahogany	7.5mm/6 ply Mahogany
Hoops	2.3mm Super	2.3mm Super
Lugs	CL-55G	CL-55
Strainer	SR-015G	SR-015
Snares	S-029NG	S-029N
Tension #	8	8
Plating	gold	chrome

Chad Smith

Chad's live and recorded performances with the Red Hot Chili Peppers have earned him a reputation as one of the premier drummers in rock this decade. His Signature Series Snare Drum offers a new look with its Black Nickel Finish, and provides one of the most rock solid snare sounds available today.

	CH-4214
Size	5" X 14"
Shell Material	Black Nickel Plated Steel
Hoops	2.3mm Super
Lugs	CL-55
Strainer	SR-015
Snares	S-022
Tension #	10
Plating	chrome



OH-4213G



OH-4213

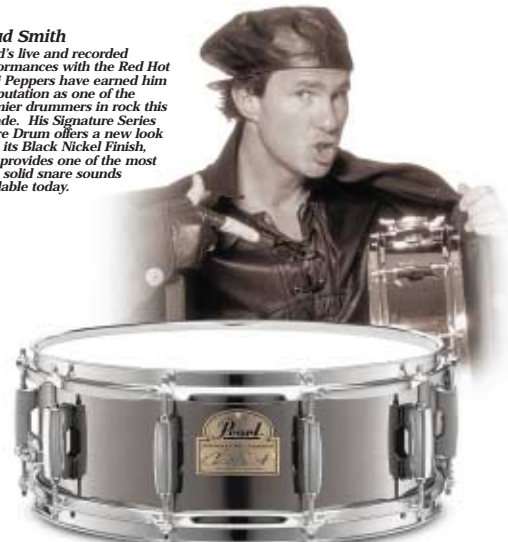

CS-4214

SensiTone Classics and Power Piccolos

Sensitone Classic Snare Drums represent a perfect balance of heritage and technology. Vintage style tube lugs, single flanged hoops with tension claws and the classic styling of our SR-017 Strainer reflect a look of decades gone by, while the cutting edge functionality, dependability, and sound this drum produces, lets you know immediately this is definitely one of the finest metal Snare Drums ever produced. One listen will change the way you judge a great sounding metal Snare Drum. Sensitone Classics are available in both Bronze and Brass shells and in two depths. The newest members of our renowned SensiTone Snare Drum line are our Brass and Steel shell 5"x13" SensiTone Power Piccolos. If you've been attracted to the crack and attack of the popular Piccolo sound, but hate to give up the depth, body and guts of a standard Snare, you're search is over.

SensiTone Power Piccolos are so versatile, they're perfect for the way you play now.



BR-6514CL



BR-6514DCL



B-6514CL



B-6514DCL



S-5513

B-5513

	BR-6514CL	BR-6514DCL	B-6514CL	B-6514DCL	S-5513	B-5513
Size	5 1/2" X 14"	6 1/2" X 14"	5 1/2" X 14"	6 1/2" X 14"	5 1/2" X 13"	6 1/2" X 14"
Shell Material	Bronze	Bronze	Brass	Brass	Steel	Brass
Hoops	Single Flange	Single Flange	Single Flange	Single Flange	2.3mm Super	2.3mm Super
Lugs	Tube	Tube	Tube	Tube	CL-55	CL-55
Strainer	SR-017	SR-017	SR-017	SR-017	SR-017	SR-017
Snares	S-022N	S-022N	S-022N	S-022N	S-029N	S-029N
Tension #	10	10	10	10	8	8
Plating	Chrome	Chrome	Chrome	Chrome	Chrome	Chrome

SensiTone Custom Alloy Snare Drums

SensiTone Custom Alloy Snare Drums offer great sensitivity and response, excellent attack and projection, combined with outstanding body and tonal clarity. These Snare Drums are everything you've always wanted a metal Snare Drum to be, plus a whole lot more. Our SensiTone Custom Alloy Snare Drums are available in your choice of Bronze, Brass or Steel shells, each in two depths. Bronze offers a slightly fatter, drier warm tone, Brass provides brilliant highs, warmth and a more open tone, while our Steel shell provides a smooth, neutral, well balanced sound. All feature our minimum contact bridge style lugs with brass inserts, our 2.3mm SuperHoop II's, and the fully adjustable SR-017 strainer system. If you haven't heard a SensiTone Snare Drum, you owe it to yourself to experience the sound that every professional drummer has been raving about. You simply can't buy a better metal Snare Drum than SensiTone.



BR-5514

BR-5514D

B-5514

B-5514D

S-5514

S-5514D

	BR-5514	BR-5514D	B-5514	B-5514D	S-5514	S-5514D
Size	5 1/2" X 14"	6 1/2" X 14"	5 1/2" X 14"	6 1/2" X 14"	5 1/2" X 14"	6 1/2" X 14"
Shell Material	Bronze	Bronze	Brass	Brass	Steel	Steel
Hoops	2.3mm Super	2.3mm Super	2.3mm Super	2.3mm Super	2.3mm Super	2.3mm Super
Lugs	CL-55	CL-65	CL-55	CL-65	CL-55	CL-65
Strainer	SR-017	SR-017	SR-017	SR-017	SR-017	SR-017
Snare	S-022N	S-022N	S-022N	S-022N	S-022N	S-022N
Tension #	10	10	10	10	10	10
Plating	Chrome	Chrome	Chrome	Chrome	Chrome	Chrome

Maple Free Floating Snare Drums

Pearl's Free Floating System Snare Drums have remained among the best selling and most widely used snare drums, year after year, for well over a decade. The "Free Floating" concept of removing all hardware from the shell is an extremely effective way of increasing the amount of resonance a snare drum can produce. This simple concept allows the true properties and natural coloration of each shell material to maximize its contribution to the overall sound of the drum. Pearl's Free Floating System also allows you the option to swap shells as easily as changing a batter head.

Our brass and Maple Free Floating System Snare Drums feature our alloy Die-Cast hoops which improve the focus and clarity of these two shell materials. You will find our Die-Cast hoops provide a very dense and loud rim shot and a more intense cross stick sound that is perfect for everything from rock ballads to country. Our 10 oversized springless tension posts provide unequalled tuning integrity. An aircraft quality aluminum alloy bottom edge ring is machined to provide perfect seating with the shell and is precision cut to offer the most stable, sensitive, responsive snare bed imaginable. All of the drums hardware is attached to the edge ring, including the throw-off, allowing the shell to resonate unrestricted. Our SR-010 Snare Throw-off provides super smooth action and both the Snare and Butt units feature our "No Adjust Roller Bed" for precise alignment that is factory preset for optimum response. All of our Free Floating System Snare Drums feature our S-025 high carbon steel extended snares. By extending the ends of snares past the edge of the head, the wires are allowed to lie flat against the head to provide optimum contact. This, combined with a precision machined snare bed specially engineered for extended snares, creates an extremely sensitive and very responsive snare sound.

The benefits supplied by our innovative Free Floating System design are most evident when combined with our 6 ply 100% aged premium Maple shell. Pearl's patented Heat Compression Shell Molding System and patented adhesive formulation consistently produce the finest Maple Shells available today. This exclusive shell manufacturing process, combined with our Free Floating System, produces a snare drum that offers a very warm, well rounded and full bodied tone with lasting resonant sustain. If you are a fan of maple snare drums, you owe it to yourself to hear the difference a free floating shell creates.



M-9114P



M-9114



M-9114D



Our Free Floating Maple Snare Drums are available in three depths and all feature our exclusive Aluminum Alloy Edge Ring, our "No Adjust" Roller Bed and our SR-010 Extended Snare Unit. Five beautiful semi-transparent and opaque hi-gloss finishes are available, #100 Wine Red, #102 Natural, #103 Piano Black, #109 Arctic White and #114 Liquid Amber. See page 4 for color samples.

Brass and Steel Free Floating Snare Drums

Our Brass Free Floating Snare Drum is an excellent choice for the drummer seeking both power and sensitivity from a single drum. The overall brilliant tonality of brass with its characteristic attack, volume and projection, combined with the excellent resonance inherent to our Free Floating System, makes our Brass Free Floating Snare Drum an extremely versatile choice. Its overwhelming popularity, especially among rock drummers, has made this drum one of the best selling snare drums we have ever offered. Our Steel Shell Free Floating System Piccolo offers the excellent attack, natural tone, and superb projection that characterize most standard steel shell snare drums, and adds the lasting resonance, sustain and outstanding clarity inherent with our Free Floating System design. Our 1.6mm steel counter hoops are a perfect match to complement the native voicing of our steel shell and its unique black exterior finish offers a real departure from most steel shell drums.



	M-9114P	M-9114	M-9114D	B-9114P	B-9114	B-9114D	S-8114P
Size	3 1/2" X 14"	5" X 14"	6 1/2" X 14"	3 1/2" X 14"	5" X 14"	6 1/2" X 14"	3 1/2" X 14"
Shell Material	6 ply Maple	6 ply Maple	6 ply Maple	Brass	Brass	Brass	Steel
Hoops	Die-Cast	Die-Cast	Die-Cast	Die-Cast	Die-Cast	Die-Cast	1.6mm Steel
Lugs	Post	Post	Post	Post	Post	Post	Post
Strainer	SR-010	SR-010	SR-010	SR-010	SR-010	SR-010	SR-010
Snare	S-025	S-025	S-025	S-025	S-025	S-025	S-025
Tension#	10	10	10	10	10	10	10
Plating	Chrome	Chrome	Chrome	Chrome	Chrome	Chrome	Chrome

Soprano, Effects and Sopranino Snares

Soprano, Effects and Sopranino Snare Drums have become some of the most widely used and best selling Snare Drums in popular music today. Their crisp brilliant attack and tight sound with excellent projection have led many players to use them as both a secondary and primary snare. Our 13" Soprano Snare Drums are available with your choice of either Brass, Maple or Steel shell. Each offers a slightly different tone and voicing, allowing you to fine tune the Soprano sound to best suit your personal needs. Our smaller 12" and 10" Effects Snare Drums offer sounds unobtainable from standard size snare drums. Their 100% Maple shells provide a warm tone with stunning high end attack. Both our 7"x12" and 4"x12" Effects Snare Drums can be mounted to a standard snare stand using our SBA-1 grip adapters while our 4"x10 Effects Snare Drum comes complete with our renowned Integrated Suspension System Mount.



B-513P



M-513P



SL-513P



M-712SE



M-412SN



M-410SN



	B-513P	M-513P	SL-513P	M-712SE	M-412SN	M-410SN
Size	3" X 13"	3" X 13"	3" X 13"	7" X 12"	4" X 12"	4" X 10"
Shell Material	Brass	6 Ply Maple	Steel	8 Ply Maple	6 Ply Maple	6 Ply Maple
Hoops	1.6mm Steel	1.6mm Steel	1.6mm Steel	1.6mm Steel	1.6mm Steel	1.6mm Steel
Lugs	CL-05	CL-05	CL-05	CL-100	CL-05	CL-05
Strainer	SR-018	SR-018	SR-018	SR-012	SR-018	SR-018
Snares	S-029N	S-029N	S-029N	S-031N	S-033N	S-032N
Tension #	8	8	8	8	6	6
Plating	Chrome	Chrome	Chrome	Chrome	Chrome	Chrome

Genuine Parts and Accessories

Pearl offers a complete line of genuine replacement parts and accessories to keep your Snare Drum in top playing condition. Just a few of the many available strainers, snares, lugs and hoops are shown here. For a complete list or the exact replacement part needed for your particular Snare Drum model, see any authorized Pearl dealer.

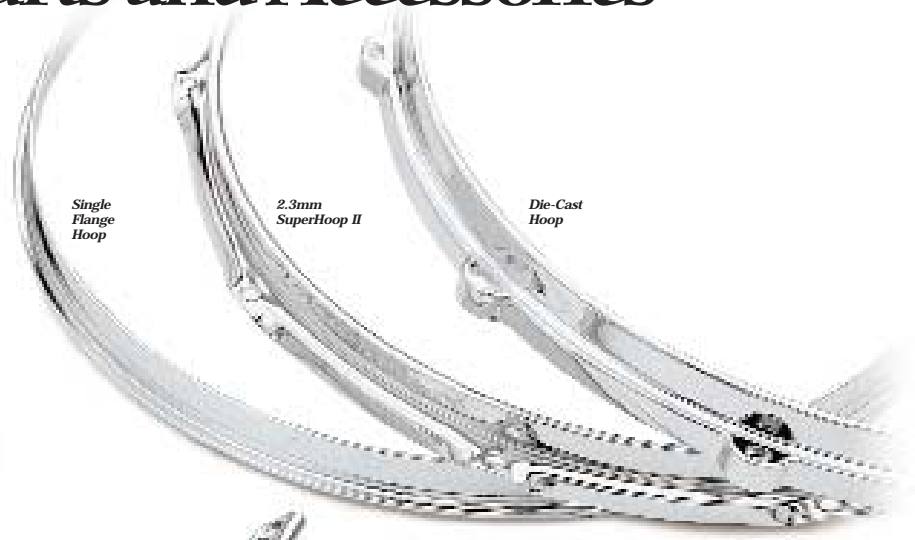

Single Flange Hoop

2.3mm SuperHoop II

Die-Cast Hoop



Tube Lug

CL-55

CL-100

CL-100G

CL-05

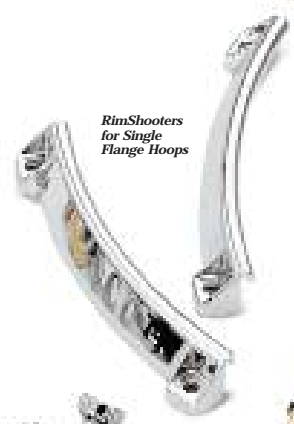

RimShooters for Single Flange Hoops



SR-012

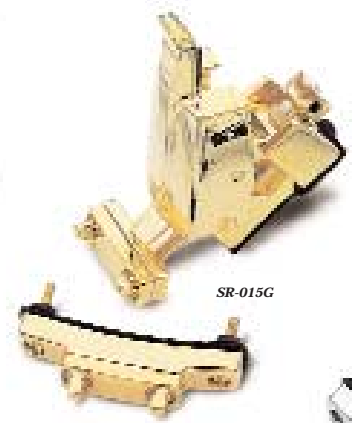

SR-015G



SR-015



SR-010



SR-018



SR-017

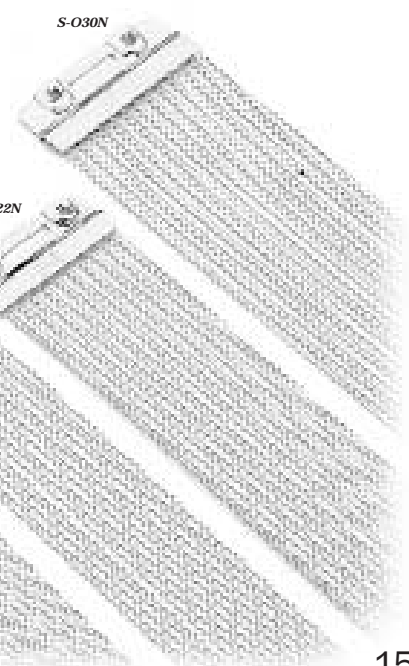

S-030N

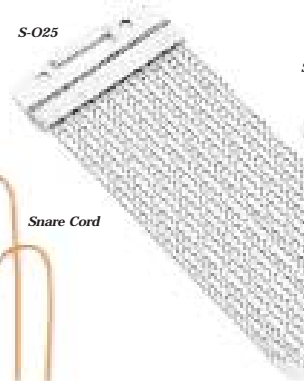

S-025

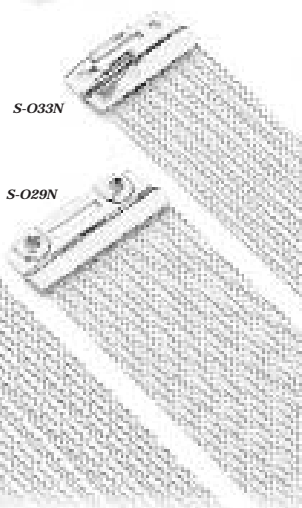

S-029N

S-022N

S-033N

Snare Straps



Snare Cord

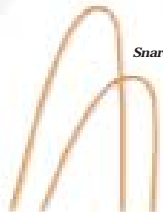

Snare Stands



- S-985W**
- Oversized rubber snare grips
 - Dual pivoting Uni-Lock basket
 - Nylon sleeved pipe joint
 - Double braced legs
 - Reversible rubber/spike feet



- S-885W**
- Oversized rubber snare grips
 - Dual pivoting Uni-Lock basket
 - Nylon sleeved pipe joint
 - Double braced legs

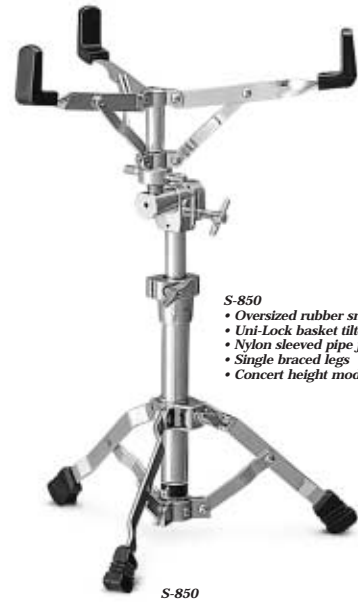

- S-850**
- Oversized rubber snare grips
 - Uni-Lock basket tilter
 - Nylon sleeved pipe joint
 - Single braced legs
 - Concert height model available S-850L



- S-800WL**
- Concert height, extremely stable
 - Oversized rubber snare grips
 - Uni-Lock basket tilter
 - Sleek pipe joint with long nylon sleeve
 - Extra wide Double braced tripod

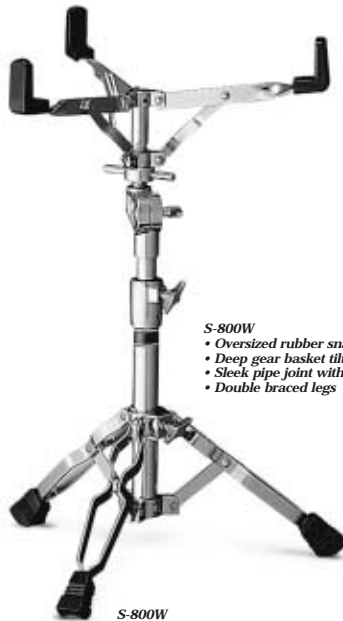

- S-800W**
- Oversized rubber snare grips
 - Deep gear basket tilter
 - Sleek pipe joint with long nylon sleeve
 - Double braced legs



- S-700**
- Deep gear basket tilter
 - Sleek pipe joint with long nylon sleeve
 - Single braced legs
 - Light weight yet extremely sturdy
 - Concert height model available, S-700L

Pearl's Snare Stands, like all Pearl hardware, are considered by many to be the standard of the industry. They offer extremely innovative, well designed features, highly durable road-proven construction, and remain priced as one of the best values available in drum hardware today.



www.pearldrums.com

For more information on any Pearl product visit any authorized Pearl dealer or in the USA write to Pearl Corporation, 549 Metroplex Drive, Nashville, TN, 37211. You can also find us on the net at www.pearldrums.com. Products and specifications are subject to change without notice. Copyright©1998 Pearl Corporation. Printed 4-98 in the USA.

Item # SC498